

vtech®

User's manual (Canada version)

www.vtechcanada.com



Models:
IS7121/IS7121-2/
IS7121-22

DECT 6.0

Congratulations

on purchasing your new VTech product. Before using this telephone, please read **Important safety instructions** on page 103 of this manual.

This manual has all the feature operations and troubleshooting necessary to install and operate your new VTech telephone. Please review this manual thoroughly to ensure proper installation and operation of this innovative and feature rich VTech product. For support, shopping, and everything new at VTech, visit our website at www.vtechcanada.com.



Telephones identified with this logo have reduced noise and interference when used with most T-coil equipped hearing aids and cochlear implants. The TIA-1083 Compliant Logo is a trademark of the Telecommunications Industry Association. Used under license.

Table of contents

Getting started	1
Parts checklist	1
Telephone base and charger installation	2
Handset battery installation	3
Handset battery charging	4
Are you a new cable or VoIP subscriber?	5
Did you subscribe to voicemail service from your telephone service provider?	5
Installation options.....	6
Tabletop to wall mount installation	6
Wall mount to tabletop installation	8
Doorbell battery installation	9
Locating the doorbell	10
Install the doorbell wall mount cover	14
Install the doorbell	18
Detach doorbell from wall mount cover	20
Install the doorbell with an existing wired doorbell.....	21
Telephone base layout.....	24
Handset layout.....	26
Doorbell layout.....	28
Using the menu	29
Telephone settings	30
Handset ringer volume	30
Telephone base ringer volume	30
Ringer tone	30
Chime volume.....	31
Chime tone	31
Quiet mode	32
Set date and time	33
LCD language.....	34
Voice language	35
CID time synchronization.....	36
Rename devices.....	37

Caller ID announce.....	38
LCD brightness.....	39
Dim mode	39
Wallpaper	39
Voicemail number	40
Clear voicemail indicators.....	41
Key tone.....	42
Dial mode	42
Home area code	43

Doorbell operation

44	
Answer a chime	44
Start a video streaming session	44
Extend a video streaming session....	45
End a video streaming session.....	45
Answer an incoming call during video streaming.....	46
View captured photos	46
Delete a captured photo	46
Delete all captured photos.....	46
Night vision	46

Telephone operation.....

47	
Make a call	47
Redial a call.....	47
Answer a call	47
End a call.....	47
Handset speakerphone	47
Volume control.....	48
Mute.....	48
Call waiting	48
Temporary ringer silencing	48
Temporary tone dialing	49
Chain dialing.....	49
Check voicemail.....	50
Find handset.....	50
Website.....	50
Redial	51
Equalizer.....	51
Transfer a call	52

Table of contents

Multiple handset use.....	53
Join a call in progress.....	53
Intercom.....	54
Answer an incoming call during an intercom call.....	55
Call transfer using intercom.....	56
Push-to-talk (PTT).....	57
PTT on/off.....	57
PTT to a single handset.....	58
PTT to multiple handsets.....	59
Answer a PTT call.....	60
Change a one-to-one PTT to intercom call.....	60
End a PTT call.....	61
Answer an incoming call during a PTT call.....	61
Make an outgoing call during a PTT call.....	61
Directory.....	62
About the directory.....	62
Add a directory entry.....	63
Review directory entries.....	65
Alphabetical search.....	65
Dial a directory entry.....	66
Edit a directory entry.....	66
Delete a directory entry.....	66
Speed Dial.....	67
Assign a speed dial slot.....	67
Reassign a speed dial slot.....	68
Dial a speed dial number.....	68
Delete a speed dial entry.....	68
Caller ID.....	69
About caller ID.....	69
Information about caller ID with call waiting.....	69
Caller ID log.....	70

Memory match.....	70
Missed call indicator.....	71
Review the caller ID log.....	71
View dialing options.....	72
Dial a caller ID log entry.....	73
Save a caller ID log entry to the directory.....	73
Delete caller ID log entries.....	74
Caller ID log screen messages.....	74

Answering system settings.....75

Answering system.....	75
Announcement.....	75
Record your own announcement.....	75
Play your announcement.....	76
Delete your announcement.....	76
Answer on/off.....	77
Call screening.....	78
Number of rings.....	78
Remote access code.....	79
Message alert tone.....	79
Recording time.....	80

Answering system operation...81

Answering system and voicemail.....	81
Using the answering system and voicemail together.....	81
Message capacity.....	82
New message indication.....	82
Call screening.....	83
Call intercept.....	83
Temporarily turn off the message alert tone.....	83
Message playback.....	84
Delete all old messages.....	86
Record, play and delete memos.....	86
Remote access.....	87

Table of contents

Appendix	88
Expand your telephone system	88
Screen messages.....	89
Handset and telephone base indicators.....	91
Battery	92
Troubleshooting	93
Important safety instructions	103
Precautions for users of implanted cardiac pacemakers	104
Operating range.....	104
ECO mode.....	104
Maintenance.....	105
About cordless telephones	106
The RBRC® seal	106
FCC, ACTA and IC regulations	107
Limited warranty	109
Technical specifications	111
Index	112

Getting started

Parts checklist

Your telephone package contains the following items. Save your sales receipt and original packaging in case it is necessary to ship your telephone for warranty service.



Handset
(1 for IS7121)
(2 for IS7121-2/IS7121-22)



Battery compartment cover
(1 for IS7121)
(2 for IS7121-2/IS7121-22)



Battery
(1 for IS7121)
(2 for IS7121-2/IS7121-22)



Screw for doorbell (bottom)
(1 for IS7121/IS7121-2)
(2 for IS7121-22)



Screws for doorbell wall mount
(2 for IS7121/IS7121-2)
(4 for IS7121-22)



Wall anchors
(2 for IS7121/
IS7121-2)
(4 for IS7121-22)

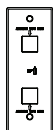

Doorbell wall mount plate
(1 for IS7121/IS7121-2)
(2 for IS7121-22)

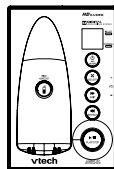

Telephone base

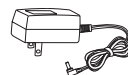

Telephone base power adapter



Double-sided adhesive tape
(2 for IS7121/
IS7121-2)
(4 for IS7121-22)

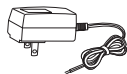

Doorbell power adapter
(1 for IS7121/IS7121-2)
(2 for IS7121-22)



Handset charger and charger adapter
(1 for IS7121-2/IS7121-22)



Doorbell with wall mount cover
(1 for IS7121/IS7121-2)
(2 for IS7121-22)



Telephone line cord

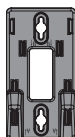

Wall mount bracket



Alkaline batteries
(2 for IS7121/IS7121-2)
(4 for IS7121-22)

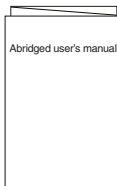

Abridged user's manual

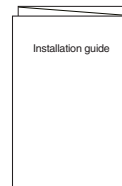

Installation guide

note

To purchase replacement batteries or power adapters, visit our website at www.vtechcanada.com or dial 1 (800) 267-7377.

Getting started

Telephone base and charger installation

Install the telephone base and charger(s) as shown below.

Make sure that the electrical outlet is not controlled by a wall switch.

If you subscribe to digital subscriber line (DSL) high-speed Internet service through your telephone line, you must install a DSL filter between the telephone line cord and the telephone wall jack. The filter prevents noise and caller ID problems caused by DSL interference. Contact your DSL service provider for more information about DSL filters.

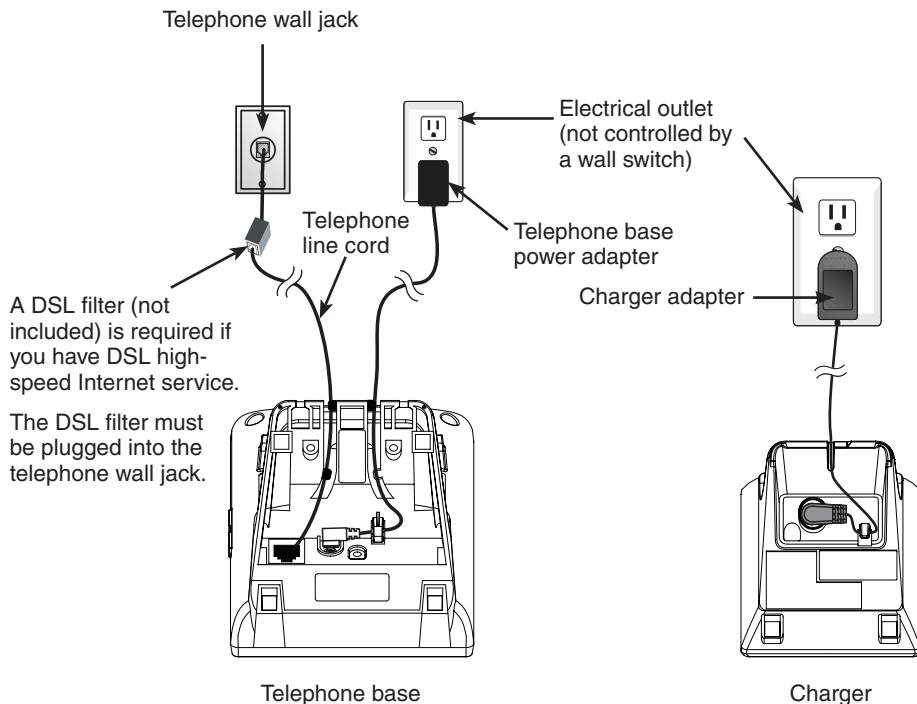

- note**
- Use only the power adapters supplied with this product. To order a replacement, visit our website at www.vtechcanada.com or call 1 (800) 267-7377.
 - The power adapters are intended to be correctly oriented in a vertical or floor mount position. The prongs are not designed to hold the plug in place if it is plugged into a ceiling, under-the-table or cabinet outlet.

CAUTION:

If you subscribe to telephone service from a cable company or a VoIP service provider, plug the telephone line cord into the modem/router/terminal adapter provided by your cable/VoIP service provider. Contact your cable/VoIP service provider if you have any difficulties in installation.

Getting started

Handset battery installation

Install the battery as shown below.

1. Insert the battery connector securely into the socket, matching the orientation of the engraved label.
2. Place the battery with the label **THIS SIDE UP** facing up and the wires inside the battery compartment.

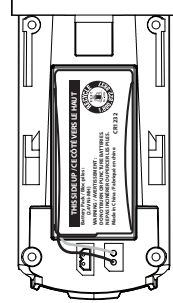
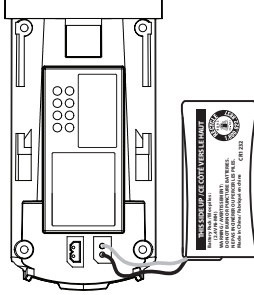

3. Align the cover flat against the battery compartment, then slide it towards the center of the handset until it clicks into place.
4. Charge the handset by placing it in the telephone base or charger. The **CHARGE** light is on when the handset is charging.

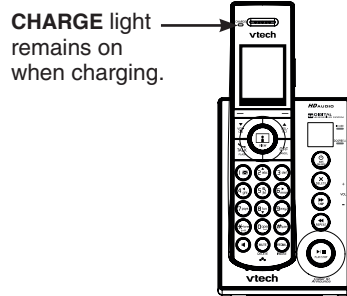
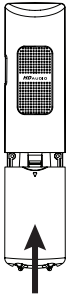

- note**
- If the handset will not be used for a long time, disconnect and remove the battery to prevent possible leakage.
 - To purchase replacement batteries, visit our website at www.vtechcanada.com or call 1 (800) 267-7377.

IMPORTANT:

Check for a dial tone by pressing . If you hear a dial tone, the installation is successful.

If you do not hear a dial tone:

- Make sure the installation procedures described above are properly done.
- It may be a wiring problem. If you have changed your telephone service to digital service from a cable company or a VoIP service provider, the telephone line may need to be rewired to allow all existing telephone jacks to work. Contact your cable/VoIP service provider for more information.



Getting started

Handset battery charging

Once you have installed the battery, the screen indicates the battery status (see the table below). If necessary, place the handset in the telephone base or charger to charge the battery. For best performance, keep the handset in the telephone base when not in use. The battery is fully charged after 11 hours of continuous charging. See the table on page 92 for battery operating times.

If the screen is blank or displays **Place in charger**, you need to charge the handset without interruption for at least 30 minutes to give the handset enough charge to use the telephone for a short time. When the battery is low, the handset displays **Low battery** along with a flashing  icon. If you are on a call in low battery mode, the handset plays short beeps to alert you.

The following table summarizes the battery charge indicators and actions to take.

Battery indicators	Battery status	Action
The screen is blank, or displays Place in charger and  flashes.	The battery has no or very little charge. The handset cannot be used.	Charge without interruption (about 30 minutes).
The screen displays Low battery and  flashes.	The battery has enough charge to be used for a short time.	Charge without interruption (about 30 minutes).
The screen displays HANDESET 1 .	The battery is charged.	To keep the battery charged, place it in the telephone base when not in use.

note If you place the handset in the telephone base without installing a battery, the screen displays **No battery**.

After you install your telephone or power returns following a power outage, the handset will prompt you to set the date and time. For instructions, see **Set date and time** on page 33.

To skip setting the date and time, press **CANCEL**.



Getting started

Are you a new cable or VoIP subscriber?

If your answer is **yes**, the existing telephone jacks in your home may no longer work. Your cable/VoIP service provider uses a different connection, separate from your old traditional telephone service, to connect the modem/router/terminal adapter installed in your home.

To allow all existing telephone jacks to work, contact your telephone service provider for solutions, such as rewiring services (fees may apply).

If your answer is **no**, your existing telephone jacks will continue to work as normal.

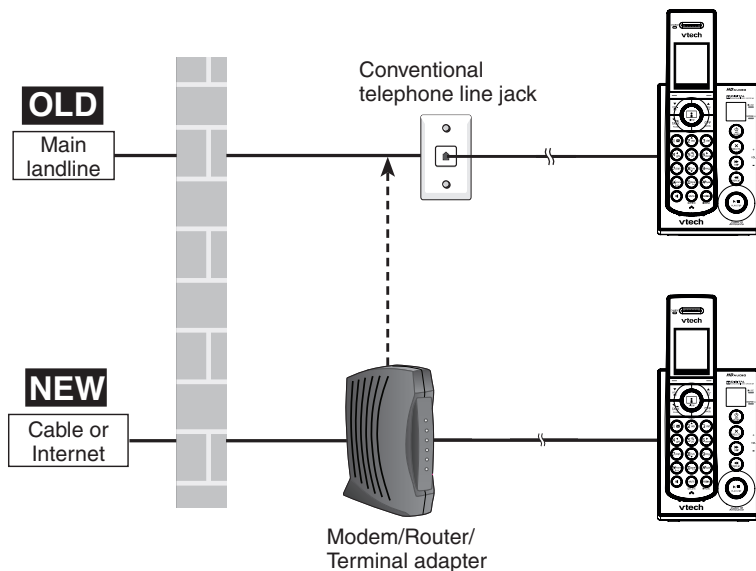

Did you subscribe to voicemail service from your telephone service provider?

Your telephone has a built-in answering system and supports voicemail feature offered by your telephone service provider (subscription is required, and fees may apply). Refer to **Answering system and voicemail** on page 81 for more details.

To use the built-in answering system:

You may see this online **Complete user's manual** on how to record your outgoing announcement, retrieve messages and other related operations. You may also refer to the **Abridged user's manual** in the product package for abbreviated instructions.

To use the voicemail:

To retrieve your voicemail messages, you typically dial an access number provided by your telephone service provider, and then enter a security code. Contact your telephone service provider for instructions on how to configure the voicemail settings and listen to messages.

Getting started

Installation options

Your telephone base is ready for tabletop use. If you want to mount your telephone on a wall, use the provided wall mount bracket to connect with a standard dual-stud telephone wall mounting plate. If you do not have this mounting plate, you can purchase one from many hardware or consumer electronics retailers. You may need a professional to install the mounting plate.

Tabletop to wall mount installation

1. If you have already installed the telephone for tabletop use, unplug the telephone line cord from the telephone wall jack, and unplug the telephone base power adapter from the wall outlet. Remove the telephone line cord and the power adapter cord from the grooves.

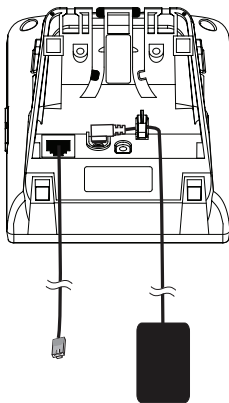

2. Route the telephone line cord through the rectangular hole on the wall mount bracket. Position the lower portion grooves on the telephone base to the lower portion tabs (marked B) on the wall mount bracket. Make sure the upper portion grooves of the telephone base are above the upper portion tabs (marked A) on the wall mount bracket. Push the telephone base down until it clicks securely in place.

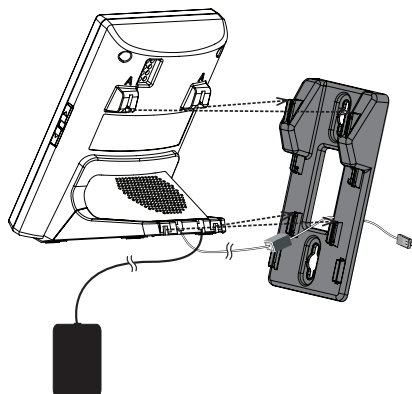

Getting started

Tabletop to wall mount installation

3. Plug the telephone line cord into the telephone wall jack or DSL filter. Align the holes on the bracket with the standard wall plate and slide the bracket down until it locks securely.

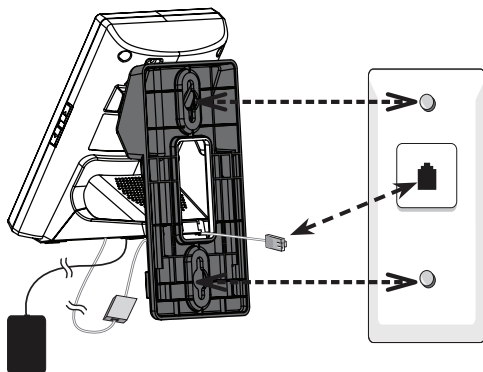

4. Plug the power cord into an electrical outlet not controlled by a wall switch. Bundle the telephone line cord and power adapter cord neatly with twist ties.

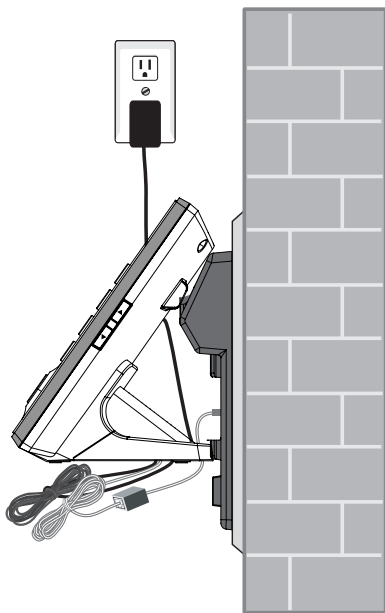

Getting started

Wall mount to tabletop installation

1. If the telephone line cord and power adapter cord are bundled, untie them first.
2. Slide the wall mount bracket up and remove it from the wall plate. Unplug the telephone line cord (or DSL filter) from the wall. Unplug the power adapter from the power outlet.
3. Slide the telephone base up and remove it from the wall mount bracket.
4. See **Telephone base and charger installation** on page 2.

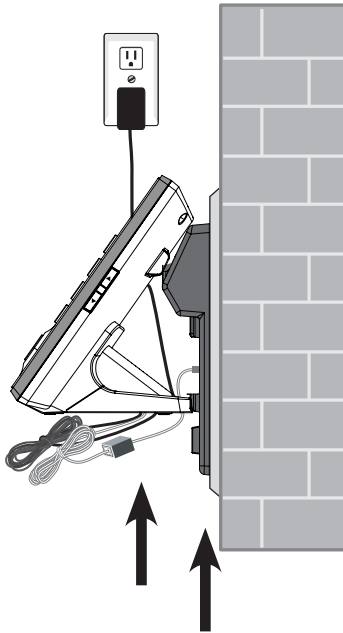

Getting started

Doorbell battery installation

You can power up the doorbell by connecting it to the AC power supply or two AA alkaline batteries (provided). Even if the doorbell is connected to the AC power supply, we recommend you also install two AA alkaline batteries. This guarantees continual operation in case of a power outage.

Install two AA batteries into the battery compartment, matching the polarity markings (+ and -) inside the battery compartment.

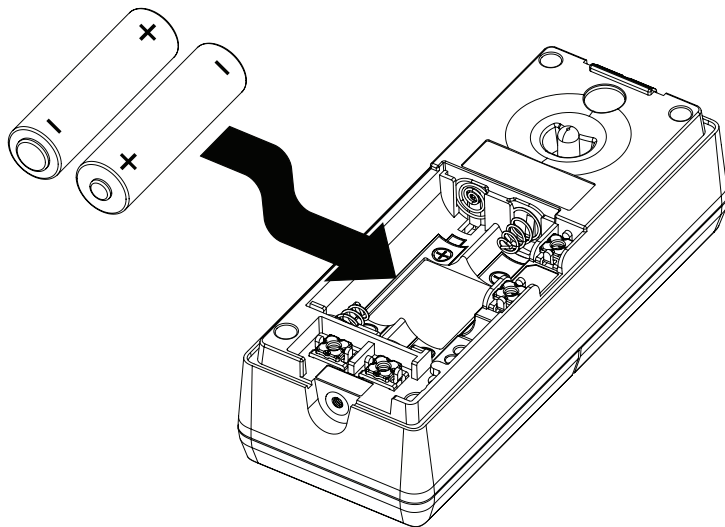

- note**
- For longer battery life, lithium batteries (not provided) are recommended. Lithium batteries provide approximately 30% additional battery life than alkaline batteries.
 - If you power up the doorbell with two AA batteries only, you can only start a video streaming session with the doorbell instead of a handset. To have a full functional doorbell, we recommend you also connect the doorbell to the AC power supply (see **Install the doorbell** on pages 18-19).

Getting started

Locating the doorbell

Before mounting the doorbell on a wall, make sure you test if the location you install the doorbell is in range, and adjust the camera angle to best suit your needs.

To test the location for installation:

Hold the doorbell in the location where you want to install the doorbell, then follow the steps below to test the reception range and video capture angle.

1. Press **MENU** >> Press ▼ or ▲ to **Settings** >> Press **SELECT**.
2. Press ▼ or ▲ to **Doorbell setup** >> Press **SELECT**.
3. Press **DOORBELL** to check the video streaming quality.
4. The handset displays **The handset is muted during the setup mode**, then press **OK**.
5. Press **☼**, then press **+** or **-** to adjust the video streaming brightness.
 - If audio feedback occurs, press **🔇** on the handset to turn off the speakerphone.
 - If the desired location is in good range, the handset displays **📶**.
 - If the desired location is not in good range, the handset flashes **📶** in red. Press **INFO** for instructions to relocate your handset and/or telephone base. When the reception is in good range, the handset displays **📶**. Press **OK** to return to the video streaming.
6. Keep the video streaming on for camera lens adjustment.

When finding a desirable location for the doorbell:

- Make sure the visitor is standing in a reasonable distance away from the doorbell.
- Avoid mounting it on a location which is subjected to vibration or shock.
- Avoid mounting it on an enclosed area where it may cause echoes.
- Avoid mounting it to where it is exposed to direct sunlight.

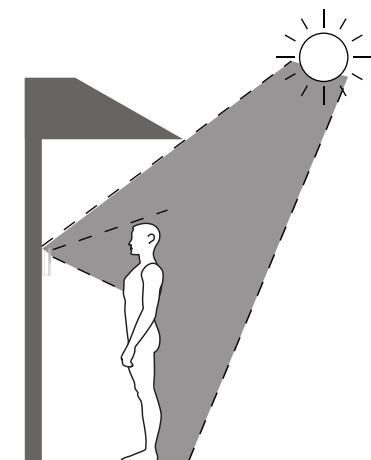

Getting started

Locating the doorbell

- Avoid mounting it to where reflections may be caused by sunlight, for example, opposite to a white wall.

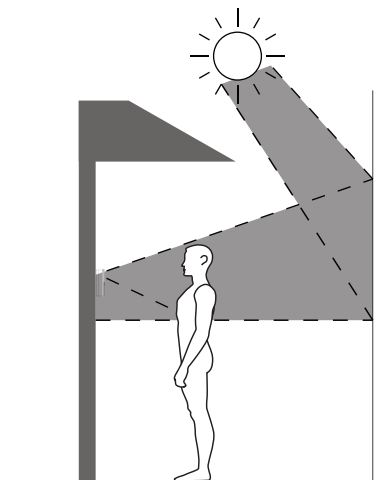

- Two built-in infrared LEDs are for night vision. Make sure the surrounding light source is sufficient for infrared operation.
Test at the front door to determine when the infrared LEDs turn on. When they are in operation, they turn red.

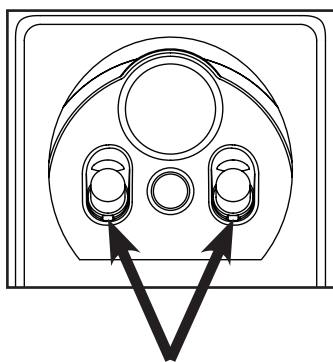

Infrared LEDs

Getting started

Locating the doorbell

To adjust the shooting area, you may either relocate the doorbell in different height level, or adjust the camera angle (see below).

To adjust the camera angle:

- Tilt the lever to adjust the angle of the camera lens. The camera lens can be adjusted to left, right or down, up to 10 degrees.

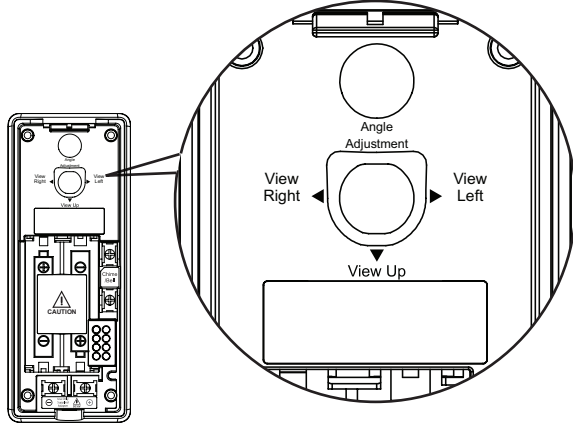

The diagrams below demonstrate an example of doorbell camera position to view a visitor about 20 inches from the camera. The camera in this example is set in default angle (0 degree).

You may move the lever at the back of the doorbell to adjust the shooting area (the camera lens).

Side view

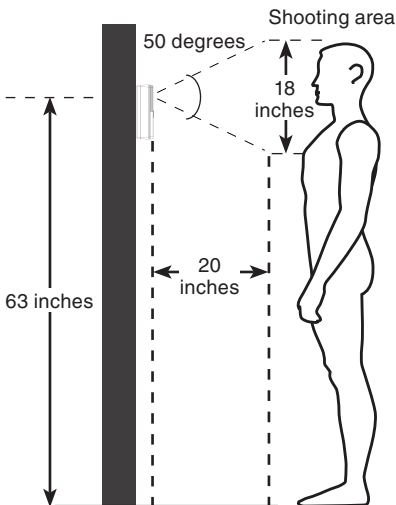

Top view

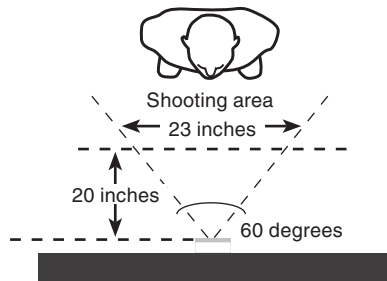

Getting started

Locating the doorbell

You may install the doorbell in a lower position. The diagram below demonstrates an example of doorbell camera position to view a visitor about 20 inches from the camera. The camera in this example is set in 10 degrees angle upward.

Side view

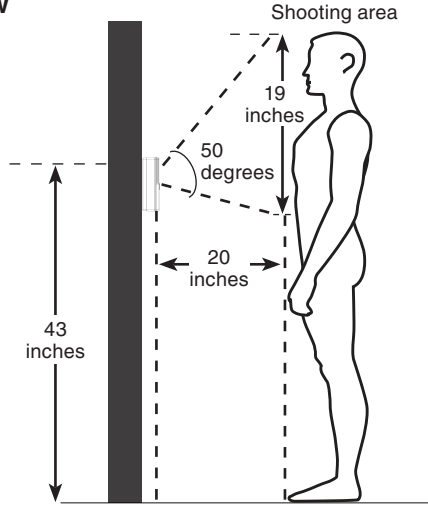

You may install the doorbell on the left or right side. The diagram below demonstrates an example of doorbell camera position to view a visitor about 20 inches from the camera. The camera in this example is set in 10 degrees angle to the right.

Top view

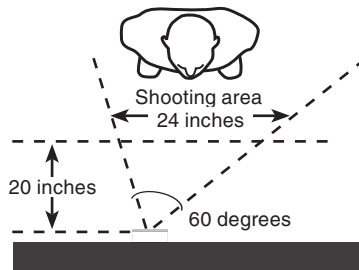

After you have tested the reception range and found the desirable location to install the doorbell, press **END** on the handset to end the video streaming and proceed to **Install the doorbell wall mount cover** and **Install the doorbell**.

Getting started

Install the doorbell wall mount cover

Make sure to test the reception and the doorbell position before you mount the doorbell on the wall. See *Locating the doorbell* on pages 10-13 to choose a desirable position for the doorbell.

 There are two ways to position the wall mount cover and manage the power adapter cord.

Option 1: Install the doorbell wall mount cover without the wall mount plate

1. Use a pencil to mark two holes on the desired location. Then remove the wall mount and drill two holes in the wall. Check for reception strength and camera angle before drilling the holes.

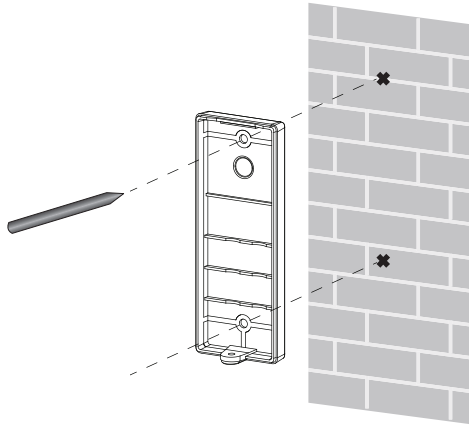

2. If you drill the holes into a stud, go to step 3.

-OR-

If you drill the holes into an object other than a stud, insert the wall anchors into the holes and tap gently on the ends with a hammer until the wall anchors are flush with the wall.



Getting started

Install the doorbell wall mount cover

3. Align the holes on the wall mount cover with the holes on the wall (or stud). Tighten the screws into the holes to secure the wall mount cover onto the wall.

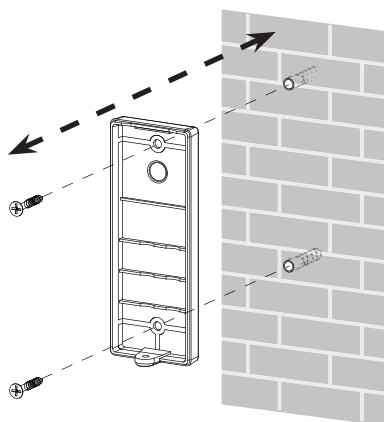

4. Use a sharp object to open a hole on the soft plastic part on the doorbell wall mount cover, then route the power adapter cord through the hole.

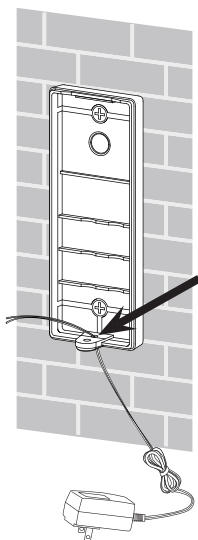

Getting started

Install the doorbell wall mount cover

Option 2: Install the doorbell wall mount cover with the wall mount plate

1. Use a pencil to mark the exact location of the screw holes on the wall. Mark an extra mark for routing the power cord through the wall. Then remove the wall mount and drill two holes in the wall. Check for reception strength and camera angle before drilling the holes.
2. Stick the double-sided adhesive tapes onto the wall mount plate as specified.

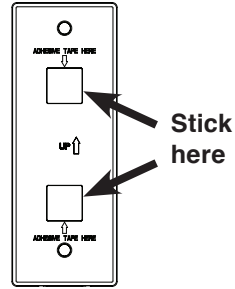
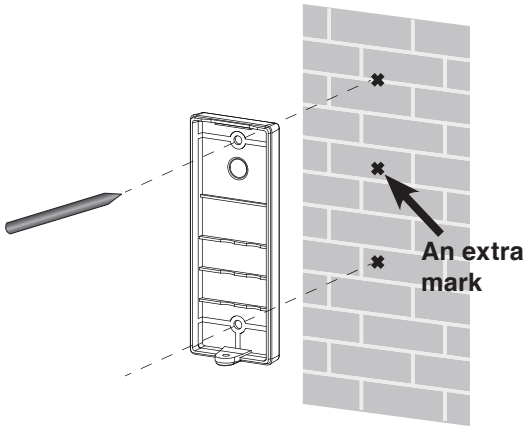

3. Align and place the wall mount cover onto the wall mount plate. Make sure the **UP** ↑ sign is pointing upward.

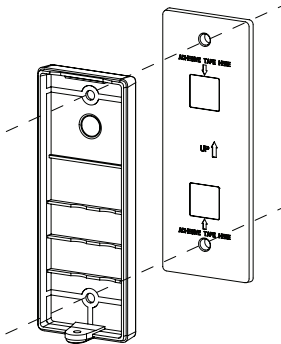

4. If you drill the holes into a stud, go to Step 5.

-OR-

If you drill the holes into an object other than a stud, insert the wall anchors into the holes and tap gently on the ends with a hammer until the wall anchors are flush with the wall.



Getting started

Install the doorbell wall mount cover

5. Use a sharp object to open a hole on the soft plastic part on the doorbell wall mount cover. Route the power adapter cord through the hole on the wall and the opening of the wall mount plate. Then, slide it in through the hole of the wall mount cover.

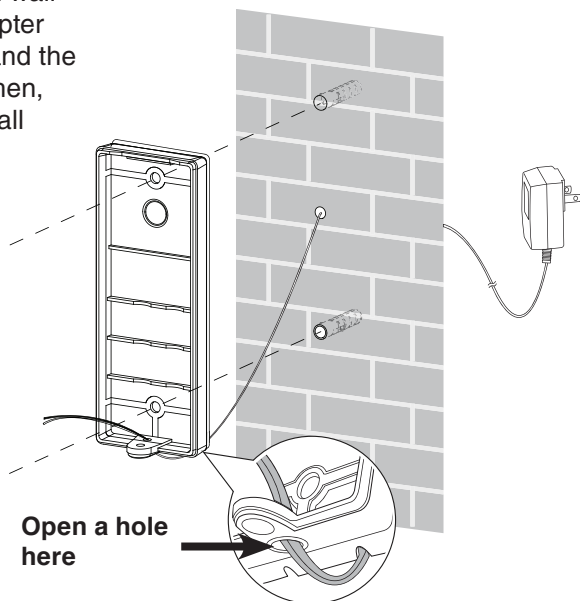

6. Align the holes on the wall mount cover with the holes on the wall. Tighten the screws into the holes to secure the wall mount cover onto the wall.

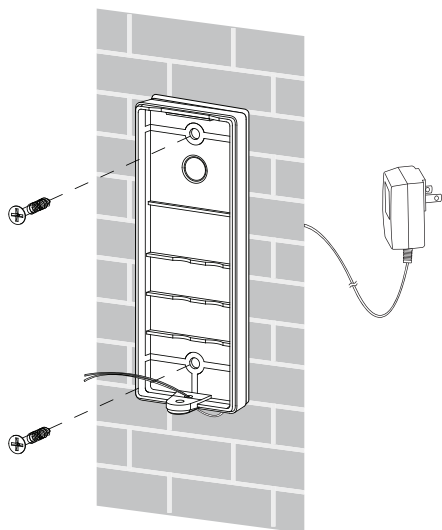

Getting started

Install the doorbell

1. Insert a cross-head screwdriver to twist and lift to loosen the screws and the metallic plates. Slide the metal part of the wire with black end underneath the metallic plate on the left, and the metal part of the wire with red end underneath the metallic plate on the right. Then twist the screws to secure.

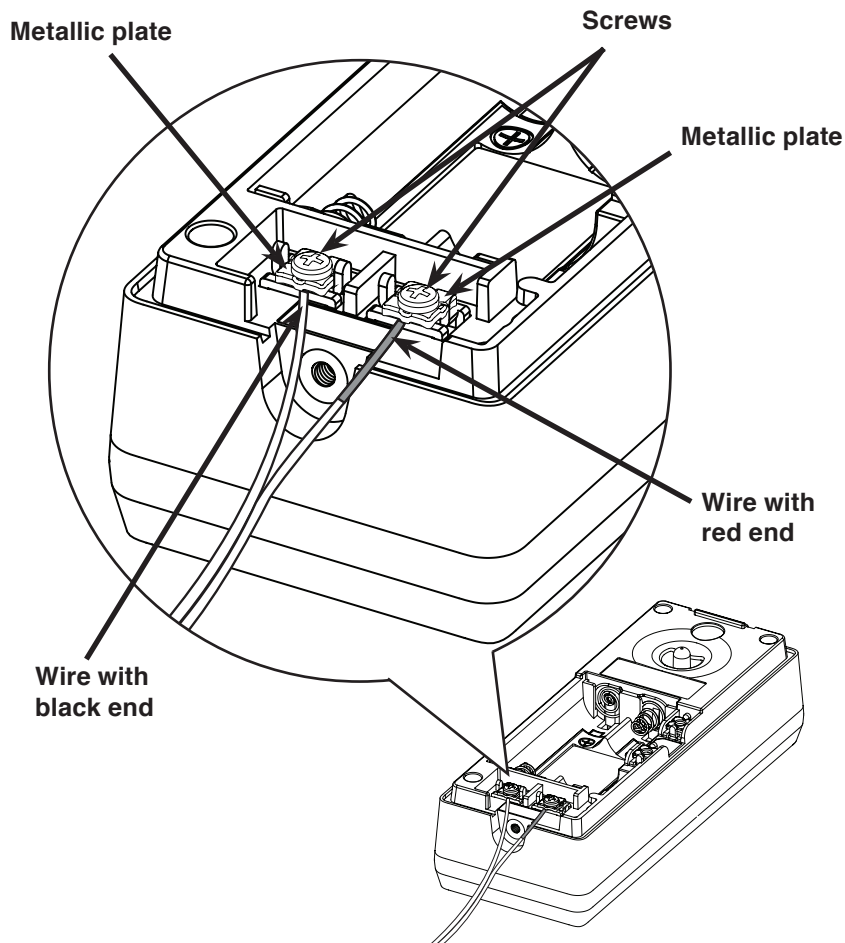

If you already have a wired doorbell installed, see [Install the doorbell with an existing wired doorbell](#) from pages 21-23 to install your new IS7121 doorbell unit.

Getting started

Install the doorbell

2. Push the doorbell gently onto the wall mount until they are sealed tightly. This doorbell meets the IPX4 waterproof standard. Make sure the doorbell is tightly sealed with its wall mount cover in order to maintain its waterproof ability.

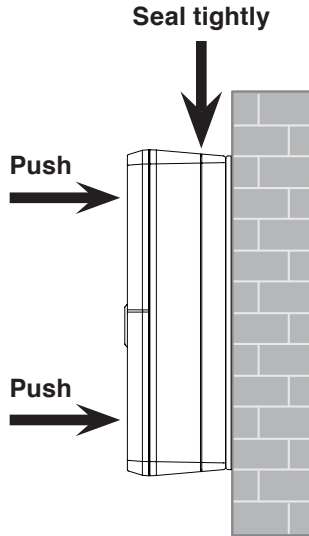

3. Tighten the screw into the threaded socket at the bottom to secure. Then plug the adapter into the indoor AC power supply.

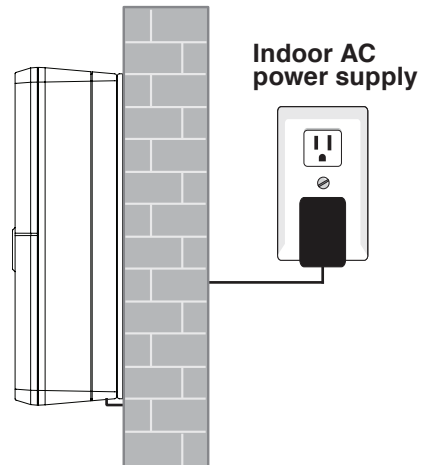
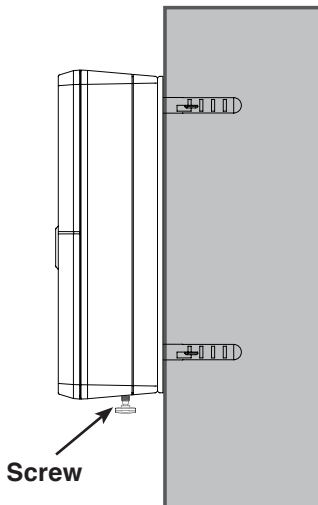

Getting started

Detach doorbell from wall mount cover

After an extended exposure to cold, heat or humidity, the doorbell gasket rubber may become sticky.

If you need to remove the doorbell from its wall mount cover in case of battery replacement or doorbell relocation, follow the steps below.

1. Remove the screw at the bottom.

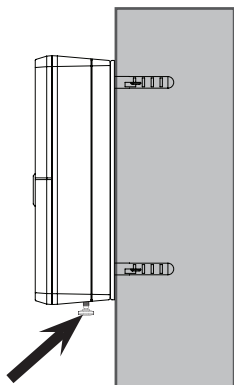

2. Insert a flat-bladed screwdriver between the doorbell and its wall mount cover to pry open at both sides.

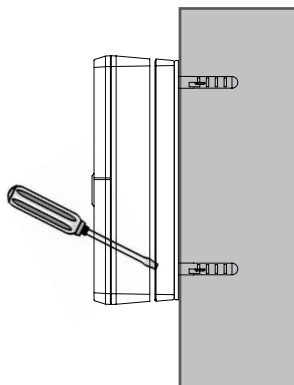

3. Pry the doorbell off.

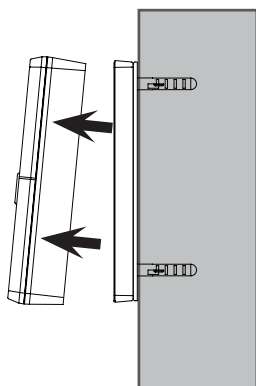

Getting started

Install the doorbell with an existing wired doorbell

If you already have a wired doorbell installed, follow the instructions below to install your new **IS7121** doorbell unit.

1. Turn off the power supply to the existing wired doorbell.
2. Follow instructions in **Install the doorbell wall mount cover** on pages 14-17.
3. Insert a cross-head screwdriver to the side of battery compartment on the right, then twist and lift to loosen the screw and the metallic plates. Using a wire, slide one end of the metal part of the wire underneath the metallic plate, then twist the screws to secure. Connect the other end to the transformer.

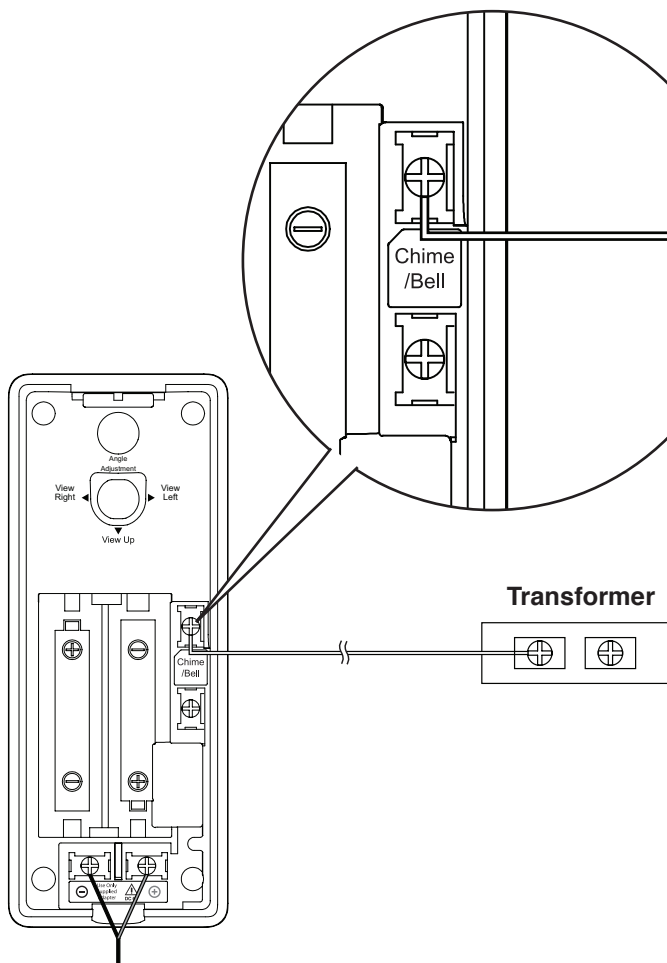

Getting started

Install the doorbell with an existing wired doorbell

- Using another wire, slide one end of the metal part underneath the metallic plate on the doorbell, then connect the other end to the Trans terminal of your chime/buzzer unit of the wired doorbell.

Option 1: Ring the front doorbell of the existing wired doorbell and the **IS7121** doorbell simultaneously.

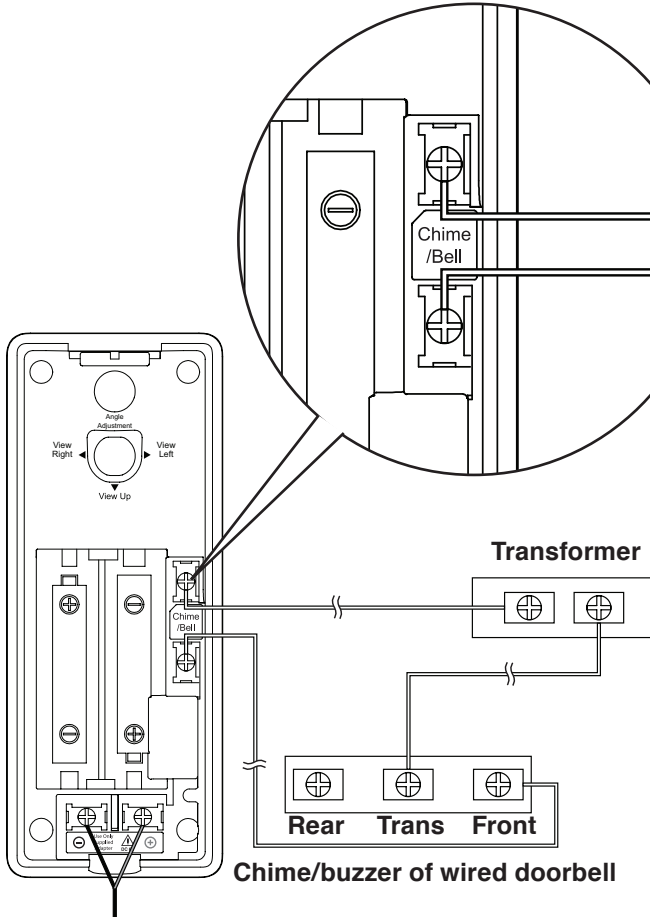

Getting started

Install the doorbell with an existing wired doorbell

Option 2: Ring the rear doorbell of the existing wired doorbell and the IS7121 doorbell simultaneously.

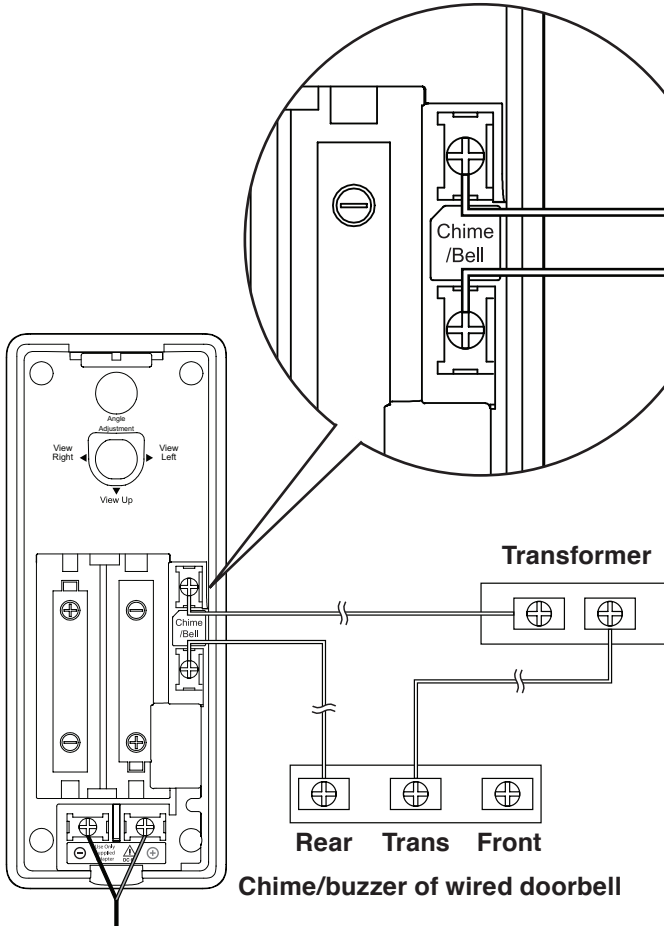

note

If you do not connect AC power supply nor install AA batteries to the IS7121 doorbell, only the existing wired doorbell will ring when being pressed.

5. Follow instructions in **Install the doorbell** on pages 18-19 to complete the installation.

Getting started

Telephone base layout

/FIND HANDSET

- Press to page all system handsets (page 50).

IN USE light

- Flashes quickly when there is an incoming call.
- Flashes when another telephone sharing the same line is in use.
- On when the telephone line is in use.

DOORBELL light

- On when a doorbell is in a video streaming session.
- Flashes quickly when the doorbell is being pressed.

+VOL/-

- Press to adjust the listening volume during a call or message playback (page 48).
- Press to adjust the telephone base ringer volume when the phone is not in use (page 30).

Message window

- Shows the number of messages, and other information of the answering system or telephone base.

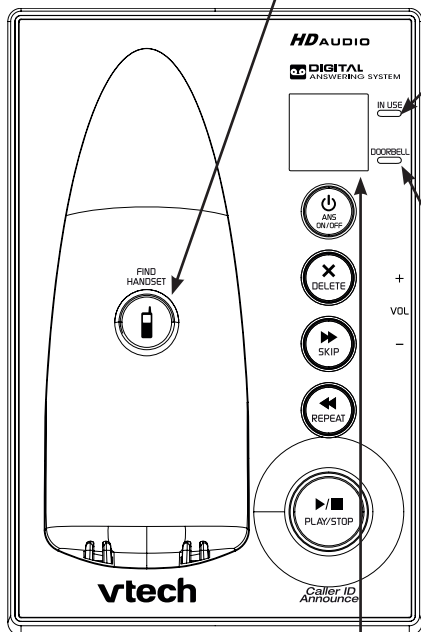

Getting started

Telephone base layout

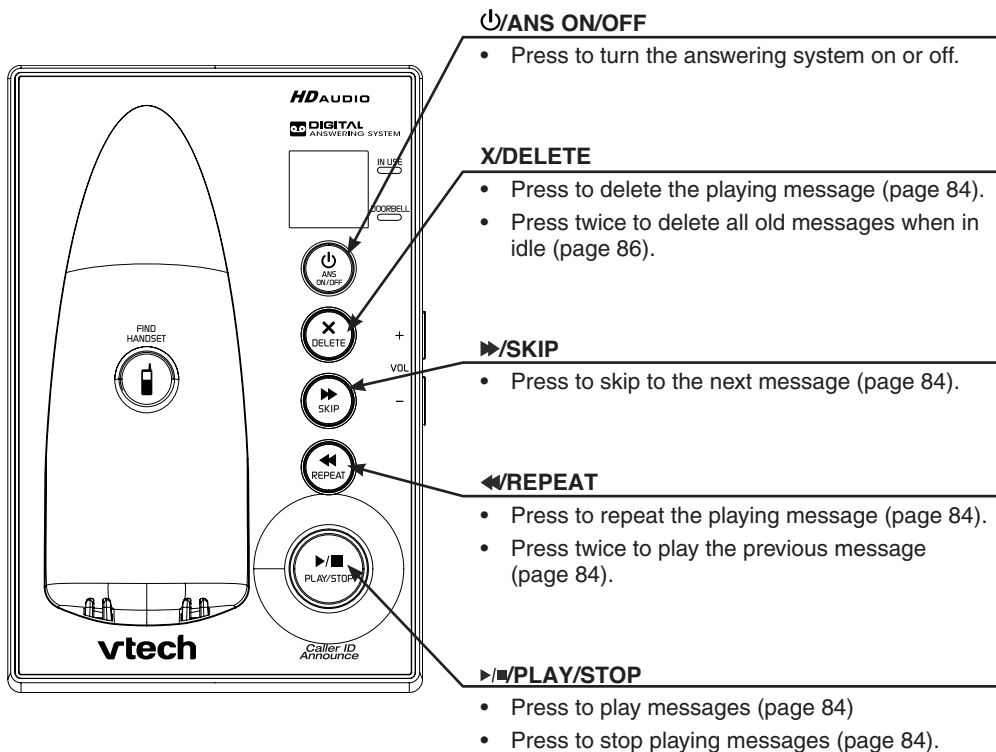

Getting started

Handset layout

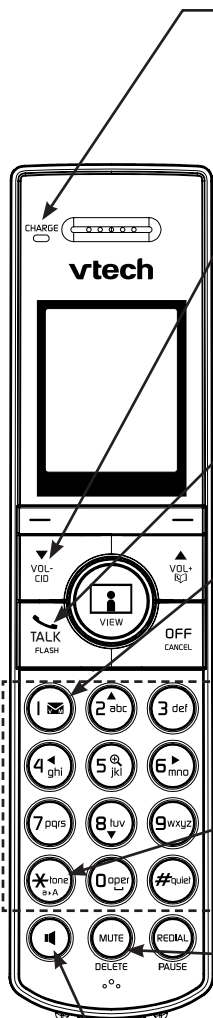

CHARGE light

- On when the handset is charging in the telephone base or charger.

▼/VOL-/CID

- Press to scroll down while in a menu, or in the directory, caller ID log or redial list (page 29).
- Press to review the caller ID log when the phone is not in use (page 71).
- While entering names or numbers, press to move the cursor to the left.
- During a call or message playback, press to decrease the listening volume (page 48 or page 85).

TALK/FLASH

- Press to make or answer a call (page 47).
- During a call, press to answer an incoming home call when you receive a call waiting alert (page 48).

1

- While reviewing a caller ID log entry, press repeatedly to add or remove 1 in front of the telephone number before dialing or saving it in the directory (page 72).
- Press and hold to set or dial your voicemail number (page 40 or page 50).

Dialing keys

- Press to enter numbers or characters.
- Press to answer an incoming call.

*Tone A+A

- During a call, press to switch to tone dialing if you have pulse service (page 49).
- Press to switch the character between upper and lower case.

MUTE/DELETE

- During a call, press to mute the microphone (page 48).
- While the phone is ringing, press to silence the handset ringer temporarily (page 48).
- While reviewing the redial list, directory or caller ID log, press to delete an individual entry (page 51).
- While using the dialing keys, press to delete digits, or press and hold to return to idle mode.

Speaker

- Press to make or answer a call using the handset speakerphone (page 47).
- Press to switch between the handset speakerphone and the handset earpiece during a call (page 47).

Getting started

Handset layout

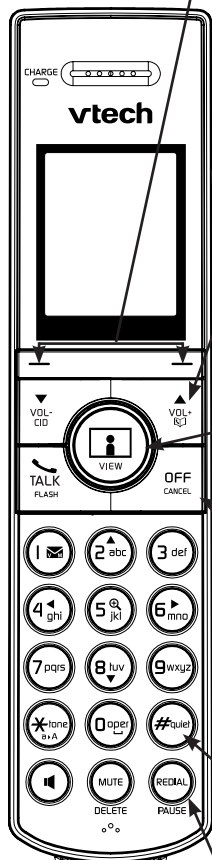

Softkeys (2)

- Press to select a menu item displayed above the key.

PUSH TO TALK (PTT)/SNAPSHOT

- Press to begin a one-to-one or one-to-group broadcast (page 57).
- Press and hold to broadcast to a group of handsets when the handset is not in use (page 59).
- Press to take a photo shot of visitor from the doorbell during video streaming (page 45).

▲/VOL+/

- Press to scroll up while in a menu, or in the directory, caller ID log or redial list.
- Press to review the directory when the phone is not in use (page 65).
- While entering names or numbers, press to move the cursor to the right.
- During a call or message playback, press to increase the listening volume (page 48 or page 85).

/VIEW

- When you hear a chime, press to start video streaming (page 44).
- Press to extend video streaming session (page 45).

OFF/CANCEL

- During a call, press to hang up (page 47).
- While in a menu, press to return to the previous menu, or press and hold to return to idle mode, without making changes.(page 29).
- While the phone is ringing, press to silence the handset ringer temporarily (page 48).
- Press and hold to erase the missed call indicator when the phone is not in use (page 71).

#quiet

- Press repeatedly to display other dialing options while reviewing a caller ID log entry (page 72).
- Press and hold to set and turn on the quiet mode, or to turn it off (page 32).
- Press to toggle the name order when saving the caller ID entry into the directory (page 73).

REDIAL/PAUSE

- Press repeatedly to view the last 10 numbers dialed (page 51).
- While entering numbers, press and hold to insert a dialing pause.

Getting started

Handset layout

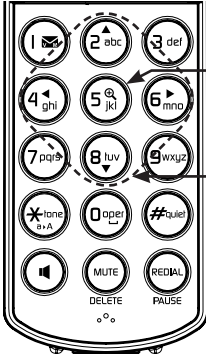

5/⊕

- During video streaming, press to zoom in or out (page 45).

2/▲, 8/▼, 4/◀ and 6/▶

- During video streaming, press to move the zoomed image upward, downward, leftward or rightward (page 45).

Doorbell layout

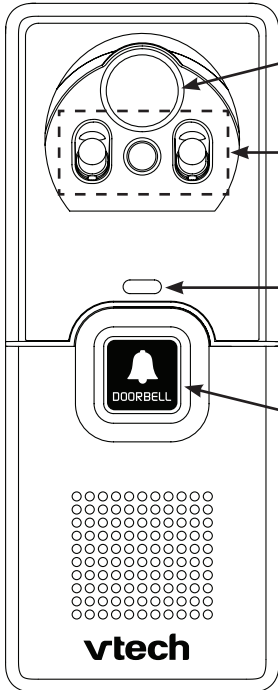

Camera lens

Infrared LEDs

- Backup light for night vision (page 46).

Doorbell light

- Flashes when /DOORBELL is pressed.

/DOORBELL

- Press to send a chime to the telephone base and capture a photo (page 44).

Getting started

Using the menu

You can use the cordless handset to change your telephone settings.

In the ringers menu, you can select the ringer tones and adjust the ringer volume for incoming calls.

In the settings menu, you can change the settings for LCD language, CID time synchronization, rename devices, caller ID announce, LCD brightness, dim mode, wallpaper, voicemail number, voicemail indicators, key tone and dial mode.

Go to **Answering system settings** starting on page 75 for instructions on how to modify the answering system settings.

To enter the handset menu:

1. Press **MENU** when the phone is not in use.
 2. Press ▼ or ▲ until the screen displays the desired feature menu.
 3. Press **SELECT** to enter that menu.
- To return to the previous menu, press **CANCEL**.
 - To return to idle mode, press and hold **CANCEL**.



Telephone settings

Handset ringer volume

You can set the ringer volume or turn the ringer off on each handset. When the ringer is off, the handset displays .

1. Press **MENU** when the handset is not in use.
2. Press **▼** or **▲** to scroll to **Ringers**, then press **SELECT**.
3. Press **SELECT** to choose **Ringer volume**.
4. Press **▼** or **▲** to sample each volume level.
5. Press **SET** to save your selection and return to the previous menu. You hear a confirmation tone.

-OR-

Press **OFF** to turn off the ringer, then press **SET** to save. The handset displays **Caller ID won't be announced**. You hear a confirmation tone.

note The ringer volume also determines the ringer volume for intercom calls. When the ringer is set to off, that handset is silenced for all incoming calls except paging tone.

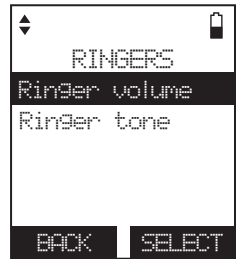

Telephone base ringer volume

Press **+VOL** or **VOL-** on the right side of telephone base to adjust the ringer volume when the telephone base is not in use.

When you set the ringer volume to silent, the base ringer is off and the system announces, *"Base ringer is off."*

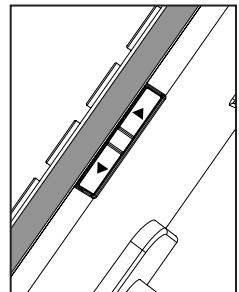

Ringer tone

You can choose from different ringer tones for each handset.

1. Press **MENU** when the handset is not in use.
2. Press **▼** or **▲** to scroll to **Ringers**, then press **SELECT**.
3. Press **▼** or **▲** to scroll to **Ringer tone**, then press **SELECT**.
4. Press **▼** or **▲** to sample each ringer tone.
5. Press **SELECT** to save your selection and return to the previous menu. You hear a confirmation tone.

note If you turn off the ringer volume, you will not hear ringer tone samples.



Telephone settings

Chime volume

You can adjust the telephone base or handset chime volume level, or turn the chime off.

1. Press **MENU** when the handset is not in use.
2. Press **▼** or **▲** to scroll to **Chime**, then press **SELECT**.
3. Press **SELECT** to choose **Chime volume**.
4. Press **▼** or **▲** to choose **Local handset** or **Base**, then press **SELECT**.
5. Press **▼** or **▲** to sample each volume level.
6. Press **SET** to save your selection and return to the previous menu. You hear a confirmation tone.

-OR-

Press **OFF** to turn off the chime, then press **SET** to save. You hear a confirmation tone.



Chime tone

You can choose from different chime tones for the telephone base or handset.

1. Press **MENU** when the handset is not in use.
2. Press **▼** or **▲** to scroll to **Chime**, then press **SELECT**.
3. Press **▼** or **▲** to scroll to **Chime tone**, then press **SELECT**.
4. Press **▼** or **▲** to choose **Local handset** or **Base**, then press **SELECT**.
5. Press **▼** or **▲** to sample each chime tone.
6. Press **SET** to save your selection and return to the previous menu. You hear a confirmation tone.

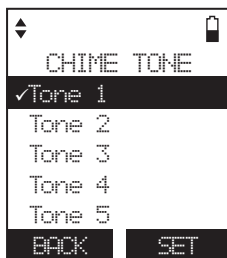

Telephone settings

Quiet mode

You can turn on the quiet mode for a period of time (1-12 hours). During this period, all tones (except paging tone and chime), caller ID announce and call screening are muted.

When you turn on the quiet mode, the answering system turns on automatically. When the quiet mode duration expires, the answering system remains on.

To set the quiet mode duration:

1. Press and hold **#quiet** when the handset is not in use.
2. The handset displays **SET QUIET MODE DURATION (1 to 12 hours)**. Press **▼** or **▲** to select the desired duration, or use the dialing keys to enter the desired duration (1-12).
3. Press **SET** to confirm. The handset displays **Answering system and chime tone is ON during quiet mode** and then returns to idle. The handset displays **ANS ON**,  and **quiet**.



To turn off the quiet mode:

Press and hold **#quiet** when the handset is not in use. The handset displays **Quiet mode is OFF** briefly. You hear a confirmation tone and the handset returns to idle.

note

If you change the settings of the ringer tone, handset ringer volume or telephone base ringer volume while the quiet mode is on, you can still hear the samples of them.

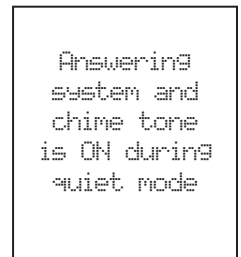
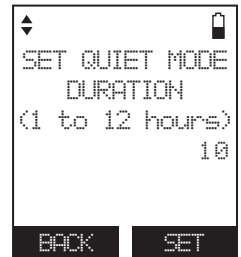

Telephone settings

Set date and time

The answering system announces the date and time of each message prior to playing it. Before using the answering system, set the date and time as follows. If you subscribe to caller ID service, the day, month and time are set automatically with each incoming call. If you do not want to set the date and time automatically with caller ID information, turn this feature off (see **CID time synchronization** on page 36). However, the year must be correct so that the day of the week can be calculated from the caller ID information.

1. Press **MENU** when the handset is not in use.
2. Press **▼** or **▲** to scroll to **Date & Time**, then press **SELECT**.
3. Press **▼** or **▲** to select the month then press **SET**, or use the dialing keys to enter a two-digit number (01-12).
4. Press **▼** or **▲** to select the date then press **SET**, or use the dialing keys to enter a two-digit number (01-31).
5. Press **▼** or **▲** to select the year then press **SET**, or use the dialing keys to enter a two-digit number (00-99) then press **SET**.
6. Press **▼** or **▲** to select the hour then press **SET**, or use the dialing keys to enter a two-digit number (01-12).
7. Press **▼** or **▲** to select the minute then press **SET**, or use the dialing keys to enter a two-digit number (00-59).
8. Press **▼** or **▲** to select **AM** or **PM**, or press **2** for **AM** or **7** for **PM**.
9. Press **SET** to save the settings and return to the previous menu. You hear a confirmation tone.

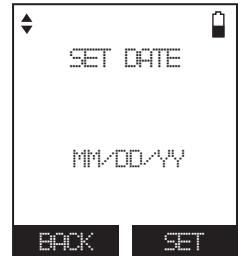

- note**
- If the date and time are not set when a message is recorded, the system announces, "Time and date not set," before each message plays.
 - The telephone plays two beeps if you enter an invalid number.

Telephone settings

LCD language

You can select a language (English, French or Spanish) to be used in all handset screen displays.

1. Press **MENU** when the handset is not in use.
2. Press **▼** or **▲** to scroll to **Settings**, then press **SELECT**.
3. Press **SELECT** to select **LCD language**.
4. Press **▼** or **▲** to scroll to **English**, **Français** or **Español** then press **SET**.
 - The handset displays **Set English as LCD language?** when you select **English**.
 - The handset displays **Set Français as LCD language?** when you select **Français**.
 - The handset displays **Set Español as LCD language?** when you select **Español**.
5. Press **YES** to your selection. Then the handset returns to the previous menu. You hear a confirmation tone.

note

If you accidentally set the LCD language to Spanish or French, you can reset it to English by pressing **MENU** and then entering ***364#** on the handset when not in use.

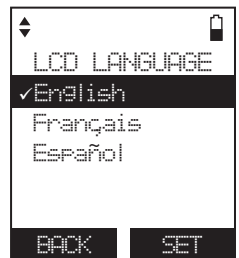

Telephone settings

Voice language

You can select a language (English or French) to be used for the answering system's voice prompts or caller ID's voice announcement.

To set voice language for answering system:

1. Press **MENU** when the handset is not in use.
2. Press **▼** or **▲** to scroll to **Settings**, then press **SELECT**.
3. Press **▼** or **▲** to scroll to **Voice language**, then press **SELECT**.
4. Press **SELECT** to select **AnsweringSys**.
5. Press **▼** or **▲** to scroll to **English** or **Français**, then press **SET** to save. You hear a confirmation tone.

To set voice language for caller ID announce:

1. Press **MENU** when the handset is not in use.
2. Press **▼** or **▲** to scroll to **Settings**, then press **SELECT**.
3. Press **▼** or **▲** to scroll to **Voice language**, then press **SELECT**.
4. Press **▼** or **▲** to scroll to **Annc Caller ID**, then press **SELECT**.
5. Press **▼** or **▲** to scroll to **English** or **Français**, then press **SET** to save. You hear a confirmation tone.

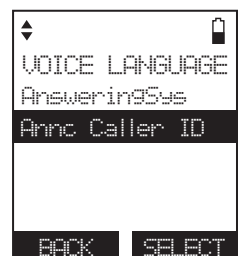
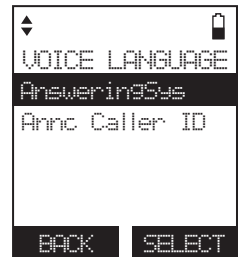
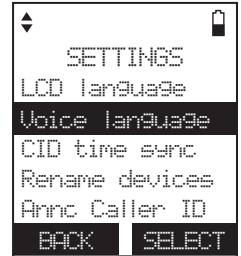

Telephone settings

CID time synchronization

If you subscribe to caller ID service, the date and time will be set automatically by the caller ID information. You can turn off this feature if you want to set the date and time manually.

To change the setting:

1. Press **MENU** when the handset is not in use.
2. Press **▼** or **▲** to scroll to **Settings**, then press **SELECT**.
3. Press **▼** or **▲** to scroll to **CID time sync**, then press **SELECT**.
4. Press **▼** or **▲** to choose **On** or **Off**, then press **SET** to save. You hear a confirmation tone.

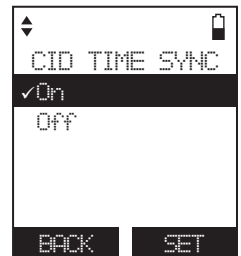

Telephone settings

Rename devices

You can create a name for each handset and doorbell. The new name can be up to 11 characters.

1. Press **MENU** when the handset is not in use.
2. Press **▼** or **▲** to scroll to **Settings**, then press **SELECT**.
3. Press **▼** or **▲** to scroll to **Rename devices**, then press **SELECT**.
4. Press **▼** or **▲** to choose **Local handset** or **Doorbell**, then press **SELECT**.
5. Use the dialing keys to edit the name
 - Press **DELETE** or **BACKSP** to erase a character.
 - Press and hold **DELETE** to erase all characters.
 - Press **▼** or **▲** to move the cursor to the left or to the right.
6. Press **SAVE**. You hear a confirmation tone.

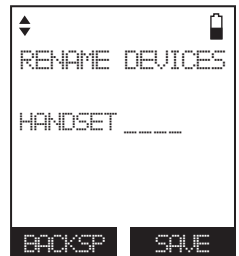

Telephone settings

Caller ID announce

You can set your handset and/or telephone base to announce the caller ID information for incoming calls. The caller ID announce setting is independent for each handset and the telephone base.

1. Press **MENU** when the handset is not in use.
2. Press **▼** or **▲** to scroll to **Settings**, then press **SELECT**.
3. Press **▼** or **▲** to scroll to **Annc Caller ID**, then press **SELECT**.
4. Press **▼** or **▲** to choose **Set all On/Off, Local handset** or **Base**, then press **SELECT**.
5. Press **▼** or **▲** to choose **On** or **Off**, then press **SET**. You hear a confirmation tone.
 - When you choose **Set all On/Off**, the screen displays **Annc CID ON on all HS & BS** if you choose **On**, or displays **Annc CID OFF on all HS & BS** if you choose **Off**.

note

- To use the caller ID announce feature, you must subscribe to caller ID service from your telephone service provider.
- Only the first four registered handsets will be able to use this feature.
- If the phone number of the incoming call matches the last 7 digits of a directory entry, the name will be announced as it appears in the entry.
- The phone number will be announced when the name is unknown, private or not provided. Only the last 11 numbers of a phone number is announced.
- No information will be announced if both the name and number are private, unknown or not provided.
- This feature is not supported with headsets.
- This feature does not announce information for call waiting calls.
- It takes at least 2 rings for the phone to receive caller ID information and announce it. If the phone is answered before the end of the second ring, it will not have time to announce the caller ID information.
- Pronunciation of names may vary with this feature. Not all names may be pronounced correctly.

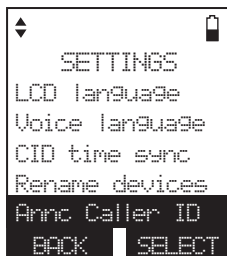

Telephone settings

LCD brightness

You can adjust the screen brightness of your handset to optimize readability lighting conditions.

1. Press **MENU** when the handset is not in use.
2. Press **▼** or **▲** to scroll to **Settings**, then press **SELECT**.
3. Press **▼** or **▲** to scroll to **LCD brightness**, then press **SELECT**.
4. Press **▼** or **▲** to sample each brightness level.
5. Press **SET** to save your selection and return to the previous menu. You hear a confirmation tone.

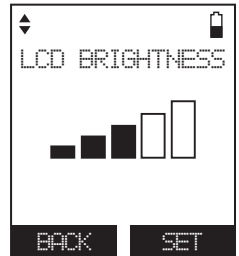
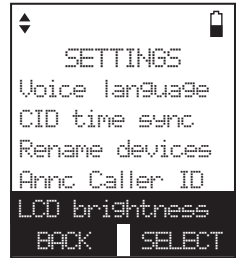

Dim mode

You can set the handset backlight in dim mode or completely off when it is not in use.

1. Press **MENU** when the handset is not in use.
2. Press **▼** or **▲** to scroll to **Settings**, then press **SELECT**.
3. Press **▼** or **▲** to scroll to **Dim mode**, then press **SELECT**.
4. Press **▼** or **▲** to choose **On** or **Off**.
5. Press **SET** to save your selection and return to the previous menu. You hear a confirmation tone.

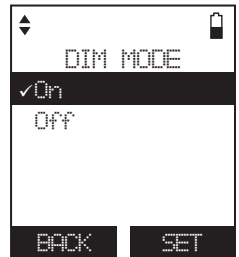
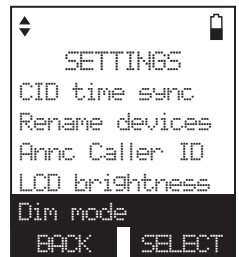

Wallpaper

You can set the wallpaper for your handset.

1. Press **MENU** when the handset is not in use.
2. Press **▼** or **▲** to scroll to **Settings**, then press **SELECT**.
3. Press **▼** or **▲** to scroll to **Wallpaper**, then press **SELECT**.
4. Press **▼** or **▲** to sample each wallpaper.
5. Press **SET** to save your selection and return to the previous menu. You hear a confirmation tone.

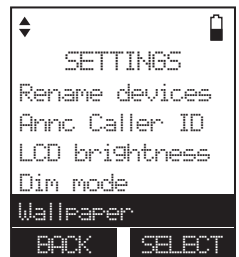

Telephone settings

Voicemail number

If you subscribe to voicemail service offered by your telephone service provider, you can save the voicemail number to **1☑** for easy access. The voicemail number is shared by the handset and the telephone base. When you want to retrieve voicemail messages, press and hold 1☑. Contact your telephone service provider for more information and assistance about using your voicemail service.

To set the voicemail number:

1. Press **MENU** when the handset is not in use.
2. Press **▼** or **▲** to scroll to **Settings**, then press **SELECT**.
3. Press **▼** or **▲** to scroll to **Voicemail #**, then press **SELECT**.
4. Use the dialing keys to enter the voicemail number (up to 30 digits).
 - Press **DELETE** or **BACKSP** to erase a digit.
 - Press and hold DELETE to erase all digits.
 - Press **▼** or **▲** to move the cursor to the left or to the right.
 - Press and hold PAUSE to insert a dialing pause (a **p** appears).
5. Press **SAVE**. The handset displays **Voicemail # saved** and then returns to the previous menu. You hear a confirmation tone.

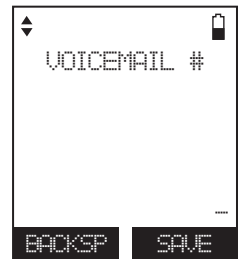
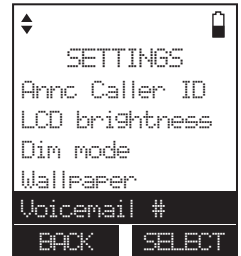

-OR-

1. Press and hold 1☑ when the phone is not in use.
2. Use the dialing keys to enter the voicemail number (up to 30 digits).
 - Press **DELETE** or **BACKSP** to erase a digit.
 - Press and hold DELETE to erase all digits.
 - Press **▼** or **▲** to move the cursor to the left or to the right.
 - Press and hold PAUSE to insert a dialing pause (a **p** appears).
3. Press **SAVE**. The handset displays **Voicemail # saved** and then returns to the previous menu. You hear a confirmation tone.

Telephone settings

Clear voicemail indicators

If you subscribe to voicemail service offered by your telephone service provider, **New voicemail** and  display on the handset when you have new voicemail messages. Contact your telephone service provider for more information and assistance about using your voicemail service.

After you have listened to all new voicemail messages, the indicators on the handset turn off automatically.

Use the clear voicemail feature when the telephone indicates that there is new voicemail but there are none (for example, when you have accessed your voicemail while away from home). Clearing the voicemail waiting indicator only turns off the indicators; it does not delete your voicemail messages. As long as you have new voicemail messages, your telephone service provider continues to send the signal to turn on the indicators.

To manually turn off the new voicemail indicators:

1. Press **MENU** when the handset is not in use.
2. Press **▼** or **▲** to scroll to **Settings**, then press **SELECT**.
3. Press **▼** or **▲** to scroll to **Clr voicemail**, then press **SELECT**.
The handset displays **Reset voicemail indication?**
4. Press **YES** to confirm and return to the previous menu. You hear a confirmation tone.

note

Your telephone service provider may alert you of new messages with a stutter (broken) dial tone. Contact your telephone service provider for details.

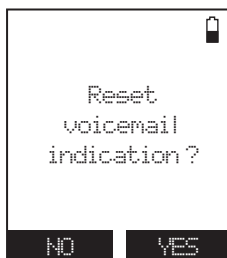

Telephone settings

Key tone

You can adjust the volume level of key tone, or turn it off for each handset. If you turn the key tone off, there are no beeps when you press the handset keys.

1. Press **MENU** when the handset is not in use.
2. Press ▼ or ▲ to scroll to **Settings**, then press **SELECT**.
3. Press ▼ or ▲ to scroll to **Key tone**, then press **SELECT**.
4. Press ▼ or ▲ to sample each volume level.
5. Press **SET** to save your selection and return to the previous menu. You hear a confirmation tone.



Dial mode

The dial mode is preset to touch-tone dialing. If you have pulse (rotary) service, you must change the dial mode to pulse dialing before using the telephone to make a call.

1. Press **MENU** when the handset is not in use.
2. Press ▼ or ▲ to scroll to **Settings**, then press **SELECT**.
3. Press ▼ or ▲ to scroll to **Dial mode**, then press **SELECT**.
4. Press ▼ or ▲ to choose **Touch-tone** or **Pulse**.
5. Press **SET** to save your selection. Then the handset returns to the previous menu. You hear a confirmation tone.

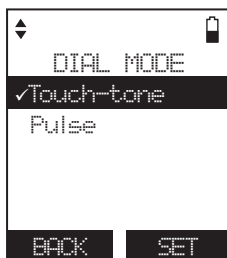
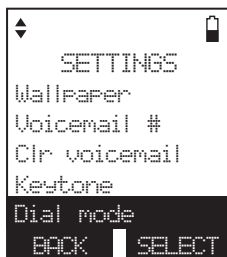

Telephone settings

Home area code

If you dial your local calls using only seven digits (area code not required), you can program your home area code so that when you receive a call within your local area, the telephone number is automatically stored without the area code in the caller ID log.

1. Press **MENU** when the handset is not in use.
2. Press **▼** or **▲** to scroll to **Directory**, then press **SELECT**.
3. Press **▼** or **▲** to scroll to **Home area code**, then press **SELECT**.
4. The handset displays **Only for 7 digits dialing from Caller ID log**. Use the dialing keys to enter a three-digit home area code.
 - Press **DELETE** or **BACKSP** to delete a digit.
 - Press and hold **DELETE** to erase all digits.
 - Press **▼** or **▲** to move the cursor to the left or to the right.
5. Press **SAVE**. Then the handset returns to the previous menu. You hear a confirmation tone.

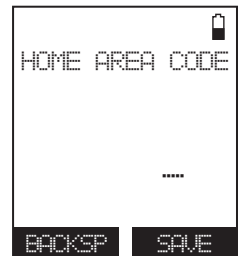

note

If, in the future, your telephone service provider requires you to dial the area code when making a local call, or, if you move to a location that requires it, delete the home area code you have already programmed, following the steps above. After you have deleted the home area code, ' _ ' appears (without quotation marks).

Doorbell operation

Answer a chime

When **DOORBELL** is pressed, you hear a chime. The doorbell automatically captures a photo of the visitor.

- Press **SPEAK** to answer.

- note**
- Only one handset can answer the chime and start a video streaming session.
 - If you have more than two handsets, only the first two registered handsets display the photo.
 - The video streaming ends after 30 seconds.
 - Press **OFF** to silence the chime.
 - Only one doorbell can perform video streaming session at a time. If other doorbell is pressed, you hear a chime, but no handsets can answer.



Start a video streaming session

- Press **VIEW** or **VIEW** when **DOORBELL** is pressed and you hear a chime on the handset.

- note** If you do not press the flashing **SPEAK** during the video streaming, the session ends in 2 minutes.

-OR-

- Press **VIEW** when the handset is not in use.

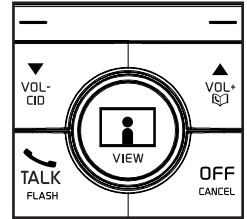

- note** If you have more than one doorbell, press **▼** or **▲** to scroll to the desired doorbell and then press **SELECT**.

-OR-

- Press **VIEW** during a call. The call is put on hold and other system handsets display **Line on hold**. You hear a beep every 10 seconds.

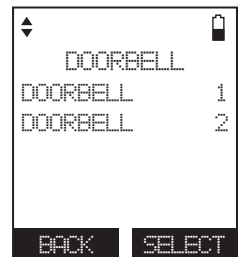

- note**
- If you do not connect the doorbell to AC power, you can only start a video streaming session with the doorbell instead of a handset. The handset displays **To view video from doorbell, please use AC power mode.**, and you hear an error tone.
 - If you do not press the flashing **SPEAK** during the video streaming, the session ends in 2 minutes.

Doorbell operation

Options while video streaming:

- Press the flashing **SPEAK** to talk to the visitor.
- Press **5/Ⓚ** to zoom in. Press **2/▲**, **8/▼**, **4/◀** or **6/▶** to move the zoomed image upward, downward, leftward or rightward correspondingly. Press **5/Ⓚ** again to zoom out.
- Press **SNAPSHOT** to take a photo shot of the visitor.
- Press **☼**, then press **+** or **-** to adjust the video stream brightness.

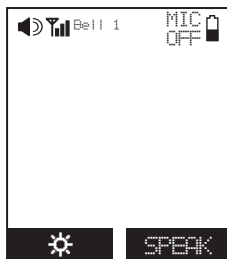

note After you press **SPEAK** to start a conversation with the visitor, the video/audio streaming session ends in 45 seconds if it is initiated by the doorbell or 60 seconds if initiated by the handset.

Extend a video streaming session

The video/audio streaming session ends in 45 seconds if it is initiated by the doorbell or 60 seconds if initiated by the handset. When the screen displays **Session is ending... Press [VIEW] to extend.** and **[VIEW]** flashes, you have five seconds to extend the video session,

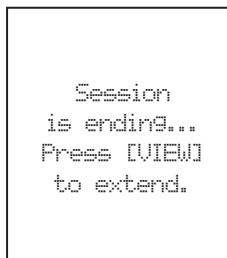

Press **[VIEW]** to extend the video session.

- If you did not press **SPEAK** during the video session, the video streaming extends for 30 seconds if it is initiated by the doorbell, or for 120 seconds if initiated by the handset.
- If you pressed **SPEAK** during the video session, the video streaming extends for 45 seconds if it is initiated by the doorbell, or for 60 seconds if initiated by the handset.

End a video streaming session

- Press **OFF** on the handset or put the handset back in the telephone base. The handset displays **Session ended.**

Doorbell operation

Answer an incoming call during video streaming

If you receive an outside call during a video streaming session, there is an alert tone.

- To answer the outside call, press **TALK** on the handset. The video streaming session ends automatically.
- To end the video streaming session without answering the outside call, press **OFF**. The video streaming session ends and the telephone continues to ring.

View captured photos

The telephone stores up to 100 photos captured by the doorbell.

1. Press **MENU** when the handset is not in use.
2. Press **▼** or **▲** to scroll to **Photo log**, then press **SELECT**.
3. Press **▼** or **▲** to scroll to **Doorbell X**, then press **SELECT**.
4. Press **▼** or **▲** to browse through the photo log.



Delete a captured photo

- When the desired photo displays, press **DELETE**.

Delete all captured photos

1. Press **MENU** when the handset is not in use.
2. Press **▼** or **▲** to scroll to **Photo log**, then press **SELECT**.
3. Press **▼** or **▲** to scroll to **Delete all**, then press **SELECT**.
4. The screen displays **Delete all photos?** Press **YES** to confirm. You hear a confirmation tone.



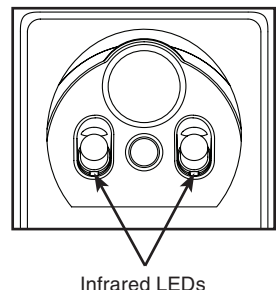

Night vision

To help you carry out the video streaming session at night, the doorbell automatically uses the light from its infrared LEDs for transmitting images to the handset unit when the surrounding is dark. However, it only transmits black-and-white images.



Telephone operation

Make a call



1. Press  or  on the handset.
2. When you hear a dial tone, dial the number.

note

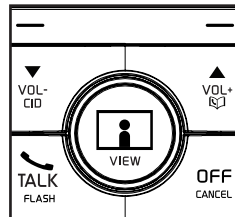
- The handset shows the elapsed time as you talk (in hours, minutes and seconds).
- While entering numbers, press and hold PAUSE to insert a dialing pause (a **p** appears).



Predial a call

1. Enter the telephone number.
 - Press **DELETE** to make corrections.
2. Press  or  to dial.

note

- The handset shows the elapsed time as you talk (in hours, minutes and seconds).
- While entering numbers, press and hold PAUSE to insert a dialing pause (a **P** appears).

Answer a call

- Press  or  or any dialing key (**0-9**, ***tone** or **#quiet**).

End a call

- Press **OFF** on the handset or put the handset back in the telephone base or charger.

Handset speakerphone

When the handset is on a call, press  to switch between the speakerphone and the handset earpiece.

When the speakerphone is active, the handset displays .

Telephone operation

Volume control

During a call, press ▼/VOL- or ▲/VOL+ to adjust the listening volume.

- note** • The handset earpiece and speakerphone volume settings are independent.
- When the volume reaches the minimum or maximum setting, you hear two beeps.

Mute

The mute function allows you to hear the other party but the other party cannot hear you.

- During a call, press **MUTE** on the handset. The screen briefly displays **Microphone off**, then displays **MIC OFF** until the mute function is turned off.
- Press **MUTE** on the handset to resume the conversation. The screen briefly displays **Microphone on**.

Call waiting

If you subscribe to call waiting service from your telephone service provider, you hear an alert tone if someone calls while you are already on a call.

- Press **FLASH** on the handset to put the current call on hold and take the new call.
- Press **FLASH** on the handset at any time to switch back and forth between calls.

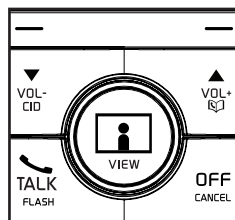

Temporary ringer silencing

When the telephone is ringing, you can temporarily silence the ringer of the handset or the telephone base without disconnecting the call. The next call rings normally at the preset volume.

To silence the handset ringer:

- Press **OFF**, **MUTE** or **SILENCE** on the handset, the handset displays **Ringer muted** briefly then 📞 displays.

To silence the telephone base ringer:

- Press **VOL-** on the telephone base.

- note** The handset and the telephone base ring when there is an incoming call unless the ringer volume setting on that device is turned off.

Telephone operation

Temporary tone dialing

If you have pulse (rotary) service only, you can switch from pulse to touch-tone dialing temporarily during a call. This is useful if you need to send touch-tone signals to access your telephone banking or long distance services.

1. During a call, press **✕_{tone}** on the handset.
2. Use the dialing keys to enter the number you wish to dial. The telephone sends touch-tone signals. It automatically returns to pulse dialing mode after you end the call.

Chain dialing

Use this feature to initiate a dialing sequence from numbers stored in the directory, caller ID log or redial list while you are on a call using the handset.

Chain dialing can be useful if you wish to access other numbers (such as bank account numbers or access codes) from the directory, caller ID log or redial list.

To access a number from the directory while on a call with the handset:

1. Press **OPTION**.
2. Press **SELECT** to select **Directory**.
3. Press **▼** or **▲** to scroll to the desired entry.
4. Press **DIAL** to dial the displayed number.

To access a number from the caller ID log while on a call with the handset:

1. Press **MENU**.
2. Press **▼** or **▲** to scroll to **Caller ID log**, then press **SELECT**.
3. Press **▼** or **▲** to scroll to the desired entry.
4. Press **DIAL** to dial the displayed number.

To access a number from the redial list while on a call with the handset:

1. Press **REDIAL** to enter the redial list.
2. Press **▼** or **▲** or **REDIAL** repeatedly to browse to the desired entry.
3. Press **DIAL** to dial the displayed number.

note

Press **CANCEL** to exit the directory, caller ID log or redial list when you are on a call.

Telephone operation

Check voicemail

Press and hold **1**  on the handset to dial your stored voicemail number.

note See **Voicemail number** on page 40 to set your voicemail number.

Find handset

This feature helps you find the misplaced handset(s).

To start the paging tone:

- Press **FIND HANDSET** on the telephone base. All idle handsets ring and their screens display **** Paging ****.

To stop the paging tone:

- Press **FIND HANDSET** on the telephone base.
-OR-
- Press **TALK**, **CANCEL** or any dialing key (**0-9**, ***_{tone}** or **#_{quiet}**) on a handset.
-OR-
- Place the handset in the telephone base or charger.

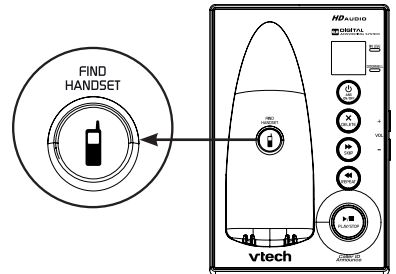

note Press **MUTE** or **SILENCE** to turn off the ringer of that handset. Its screen briefly shows **Ringer muted** and displays .

Website

Use this feature to view the VTech website address.

1. Press **MENU** when the handset is not in use.
2. Press **▼** or **▲** to scroll to **Web address**, then press **SELECT**. The handset displays the website address.
3. Press **OK** to exit.





Telephone operation



Redial

Each handset stores the last 10 telephone numbers dialed (up to 30 digits). When there are already 10 entries, the oldest entry is deleted to make room for the new entry.

To review and dial a redial number:

1. Press **REDIAL** when the phone is not in use.
2. Press ▼ or ▲ or **REDIAL** repeatedly to browse until the desired entry displays.
3. Press  or  to dial.

-OR-

1. Press  or .
2. Press **REDIAL** to enter the redial list.
3. Press ▼ or ▲ or **REDIAL** repeatedly to browse to the desired entry.
4. Press **DIAL** to dial the displayed number.

To delete a redial number:

- While the handset displays the desired number, press **DELETE** to delete the number from the redial memory. You hear a confirmation tone.

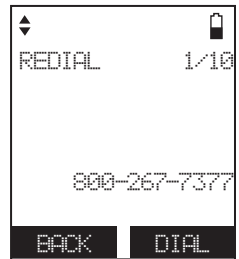
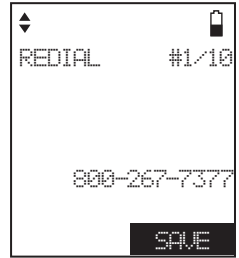

Equalizer

The equalizer feature on the handset enables you to change the quality of the handset audio to best suit your hearing. While on an outside call or an intercom, press **EQ** repeatedly to select the equalizer setting **Treble 1**, **Treble 2**, **Bass** or **Natural** (the default setting) for the handset.

note

The current equalizer setting remains unchanged until a new setting is selected.



Telephone operation

Transfer a call

While on an outside call, you can transfer the call from one system device to another. This feature is only applicable to models with more than one handset.

1. During a call, press **OPTION**.
2. Press **▼** or **▲** to scroll to **Transfer**, then press **SELECT**.
 - If your system has two handsets, the outside call is put on hold and your handset shows **Transferring call to HANDSET X**. The destination handset rings and displays **Transfer from other handset**.
 - If your system has more than two handsets, the handset displays **TRANSFER TO:** and a list of registered handsets.
Press **▼** or **▲** to scroll to the destination handset and then press **SELECT**.

-OR-

Use the dialing keys to enter the destination device number (**1 to 9** for **HANDSET 1** to **HANDSET 9**, ***_{tone}** and **0** for **HANDSET 10**, or ***_{tone}** and **#_{quiet}** for **All handsets**).

Your handset displays **Transferring call to HANDSET X**, or **Transferring call to all...** if you choose **All handsets**.

3. The destination device rings and shows **Transfer from HANDSET X**. To answer the call, press **TALK**, **🔊** or any dialing key (**0-9**, ***_{tone}** or **#_{quiet}**) on the destination handset. Your handset displays **Call transferred** when the other handset picks up the call.

note

- If the destination handset is out of range, your handset shows **Unable to call. Try again.** and then automatically returns to the external call.
- If the destination device does not answer the transferring call within 30 seconds, the call will be reverted to the originating handset. The originating handset displays **Ring back. No response to transfer.** If you do not press **TALK**, **🔊** or any dialing key (**0-9**, ***_{tone}** or **#_{quiet}**) on the handset to reconnect the outside call within 30 seconds, the call ends automatically.





Multiple handset use

Join a call in progress

You can use four cordless handsets at a time on an outside call. You can buy additional expansion handsets (**IS7101**) for this telephone base. This telephone system accommodates up to 12 devices, including a maximum of two doorbells.

To join a call:

- When a handset is already on a call, press  or  on another handset to join the call.
- To exit the call, press **OFF** on the handset or place it back in the telephone base or charger. The call continues until all the handsets hang up.

- note**
- When two handsets are in use for a call, only audio streaming can be performed with the doorbell using other handset(s). To allow video streaming to take place, end the call on either handset or both handsets.
 - When three or more handsets are in use for a call at a time, video streaming will be disabled.

Multiple handset use

Intercom

Use the intercom feature for conversations between two system handsets. This feature is only applicable to models with more than one handset.

1. Press **INTCOM** on the handset when not in use.

-OR-

Press **MENU** on the handset when not in use. Press ▼ or ▲ to scroll to **Intercom**, then press **SELECT**.

- If your system has two handsets, your handset displays **Calling other handset**. The destination handset displays **Other handset is calling**.
- If your system has more than two handsets, the handset displays **INTERCOM TO:** and a list of registered handsets.

Press ▼ or ▲ to scroll to the destination handset and then press **SELECT**.

-OR-

Use the dialing keys to enter the destination device number (1 to 9 for **HANDSET 1** to **HANDSET 9**, ✕_{tone} and 0 for **HANDSET 10**, or ✕_{tone} and #_{quiet} for **All handsets**).

Your handset displays **Calling HANDSET X**, or **Calling all handsets** if you choose **All handsets**. The destination handset displays **HANDSET X is calling**.

2. To answer the intercom call, press **TALK**,  or any dialing key (0-9, ✕_{tone} or #_{quiet}) on the destination handset. Both handsets now show **Intercom**.

3. To end the intercom, press **OFF** or **END** on the handset or place the handset back in the telephone base or charger. Both devices display **Intercom ended**.

note



- You can cancel the intercom call before it is answered by pressing **OFF** or **END**.
- If the destination device does not answer the intercom call within 100 seconds, or if it is out of range, on a call, or accessing the answering system, your handset displays **No answer. Try again.** and then returns to idle mode.
- You can press **MUTE** or **SILENCE** on the destination handset to temporarily silence the intercom ringer.
- Only one pair of intercom call can be established at a time.
- When a pair of handsets is using intercom, you are not able to perform video streaming using other handset(s) until the intercom ends.



Multiple handset use

Answer an incoming call during an intercom call

If you receive an outside call during an intercom call, there is an alert tone.

- To answer the call, press  or  on the handset. The intercom call ends automatically.
- To end the intercom call without answering the outside call, press **OFF** on the handset. The intercom call ends and the telephone continues to ring.

Multiple handset use

Call transfer using intercom

Use the intercom feature to transfer an outside call from one handset to another.

1. During a call, press **OPTION** on the handset.
2. Press **▼** or **▲** to scroll to **Intercom**, then press **SELECT**.
 - If your system has two handsets, your handset displays **Calling other handset**. The destination handset displays **Other handset is calling**.
 - If your system has more than two handsets, the handset displays **INTERCOM TO:** and a list of registered handsets.
Press **▼** or **▲** to scroll to the destination handset and then press **SELECT**.

-OR-

Use the dialing keys to enter the destination device number (**1** to **9** for **HANDSET 1** to **HANDSET 9**, ***_{tone}** and **0** for **HANDSET 10**, or ***_{tone}** and **#_{quiet}** for **All handsets**).

Your handset displays **Calling HANDSET X**, or **Calling all handsets** if you choose **All handsets**. The destination device displays **HANDSET X is calling**.

3. To answer the intercom call, press **TALK** or any dialing key (**0-9**, ***_{tone}** or **#_{quiet}**) on the destination handset.
4. The outside call is now on hold and both system devices display **Intercom**. You can have a private conversation with the destination device.
5. From this intercom call, you have the following options:
 - You can let the destination handset join you on the outside call in a three-way conversation. Press **OPTION**. Press **▼** or **▲** to scroll to **Share call** on your handset, then press **SELECT**.
 - You can transfer the call. Press **OPTION**, then press **SELECT** to choose **Transfer**. Your handset displays **Call transferred**. The destination system device automatically connects to the outside call.
 - Either person can press **TALK** or **END** on the handset to take the held outside call, or press **OFF** or **END** on the handset to end the intercom call. The outside call continues until both devices hang up.



- note**
- You can cancel the intercom call before it is answered by pressing **OFF** or **END**.
 - If the destination device does not answer the intercom call within 100 seconds, or if it is out of range, on a call, or accessing the answering system, your handset displays **No answer. Try again.** and then returns to idle mode.

Multiple handset use

Push-to-talk (PTT)

You can directly broadcast messages from one handset to the speakerphone of one or a group of handsets. Press and hold **PUSH TO TALK** to begin two-way communication. If only one handset is available or registered, the handset screen shows **PTT requires two handsets** when you press **PUSH TO TALK**.

- Only one handset can talk at a time. To do so, press and hold **PUSH TO TALK** while you are speaking.
- You must release **PUSH TO TALK**, so the other person can respond.
- Only one PTT session can be active at a time.
- While PTT is in use between handsets, other handsets cannot use the intercom feature.
- If you attempt to place a PTT call to another handset that is on an outside call or intercom call, or accessing the answering system, your handset displays **Not available at this time**.

note

When PTT is in use, video streaming will be disabled.

PTT on/off

You can turn PTT on or off on each handset.

To turn PTT on or off:

1. Press **PUSH TO TALK** when the handset is not in use.
2. Press ▼ or ▲ to scroll to **PTT On/Off**, then press **SELECT**.
3. Press ▼ or ▲ to choose **On** or **Off**, then press **SELECT** to save. You hear a confirmation tone.

note

When PTT is turned off, the handset shows **No PTT call** while the phone is not in use.



Multiple handset use

PTT to a single handset

1. You have two ways to begin a PTT call:

- If your system has two handsets, press and hold **PUSH TO TALK** when the handset is not in use.
- If your system has more than two handsets, press **PUSH TO TALK** when the handset is not in use. Then use the dialing keys to enter a handset number (**1 to 9** for **HANDSET 1** to **HANDSET 9**, ***_{tone}** and **0** for **HANDSET 10**, or ***_{tone}** and **#_{quiet}** for **All handsets**), or press **▼** or **▲** to scroll to the desired handset then press **SELECT**.

Your handset displays **Connecting to HANDSET X...** for a few seconds. When the connection is made, both your and the destination handsets display **Press and hold [PTT] to talk** and beep once.

2. Press and hold **PUSH TO TALK** on your handset. A chirp indicates your microphone is on. Speak towards the handset. Your voice is broadcast to the destination handset. While you are speaking, the handset displays **PTT To HANDSET X** (**X** represents the destination handset number).
3. Release **PUSH TO TALK** after speaking. All handsets beep once again. After the handsets beep, you can press and hold **PUSH TO TALK** to continue speaking or the destination handsets can respond (see **Answer a PTT call** on page 60).
4. Press **OFF** or **END** to end the PTT call. The handset displays **Push to talk Ended** for a few seconds.

-OR-

Place the handset in the telephone base or charger to end the PTT call.

note

After **PUSH TO TALK** is released, the PTT call remains open for a short time. If no one presses **PUSH TO TALK** within 10 seconds, the PTT call ends automatically.



Multiple handset use

PTT to multiple handsets

When there are multiple handsets registered to the telephone system, PTT supports one-to-group calls. PTT supports a maximum of one-to-four calls when one to five handsets are registered, and a maximum of one-to-three calls when six or more handsets are registered. The first four registered handsets will be able to use this feature. Other handsets can only use PTT for one-to-one calls.

To begin a PTT call to multiple handsets:

1. Press and hold **PUSH TO TALK** when the handset is not in use.
 - If your system has more than two handsets, press **PUSH TO TALK** when the handset is not in use. Press ***_{tone}** and **#_{quiet}**, or press **▼** or **▲** to highlight **All handsets** then press **SELECT** or **PUSH TO TALK**.

Your handset displays **Connecting to All handsets** for a few seconds. When the connection is made, all handsets display **Press and hold [PTT] to talk** and beep once.

2. Press and hold **PUSH TO TALK** on your handset. A chirp indicates your microphone is on. Speak towards the handset. Your voice is broadcast to all destination handsets. While you are speaking, the handset displays **PTT To HANDSET:** followed by a list of numbers representing all destination handsets).
3. Release **PUSH TO TALK** after speaking. All handsets beep once again. After the handsets beep, you can press and hold **PUSH TO TALK** to continue speaking or the destination handsets can respond (see **Answer a PTT call** on page 60).
4. Press **OFF** or **END** to end the PTT call. The handset displays **Push to talk Ended** for a few seconds.

-OR-

Place the handset in the telephone base or charger to end the PTT call.

note

After **PUSH TO TALK** is released, the PTT call remains open for a short time. If no one presses **PUSH TO TALK** within 10 seconds, the PTT call ends automatically.

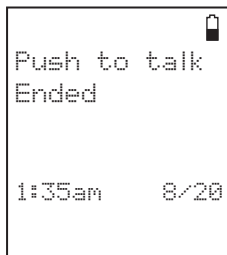

Multiple handset use

Answer a PTT call

You can respond to a PTT call whenever the speakerphone light is off.

1. When your handset receives a PTT call, the handset beeps and displays **Press and hold [PTT] to talk**.
2. When the other party is speaking, your speakerphone light is on, and your handset displays **PTT From HANDSET X To handset: Y** (X represents the originating handset and Y represents the destination handset; a maximum of four handset numbers appear).
3. When your speakerphone light is off and the handset displays **Press and hold [PTT] to talk**, press and hold **PUSH TO TALK** on your handset. When you hear a chirp, speak towards the handset.
 - While you are speaking, your handset displays **PTT To HANDSET X** (X represents the handset numbers of one or more destination handsets; a maximum of four handset numbers appear).
 - Your voice is broadcast to all destination handsets.

After speaking, release **PUSH TO TALK**. Your handset will beep. After the beep, if your speakerphone light is off, you can press and hold **PUSH TO TALK** to speak again or the destination handset can respond.

Change a one-to-one PTT to intercom call

You can convert a one-to-one PTT session to an intercom call.

1. When your handset displays **Press and hold [PTT] to talk**, press **INTCOM**. Your handset displays **Switch to Intercom?** Press **SELECT** to confirm.
 - If you have two handsets, your handset displays **Calling other handset**. The destination handset temporarily displays **Push to talk Ended** and then **Other handset is calling**.
 - If you have three or more handsets, your handset displays **Calling HANDSET Y** (Y represents the destination handset). The destination handset temporarily displays **Push to talk Ended** and then **HANDSET X is calling** (X represents the originating handset).
2. On the destination handset, press **TALK** or **PTT** to answer the intercom call. Both handsets now display **Intercom**.
3. To end the intercom call, press **OFF** or place the handset in the telephone base or charger. Both handsets display **Intercom ended**.



Multiple handset use

End a PTT call

- For a one-to-one PTT call, both the originating and destination handsets can end the PTT call.
- For a PTT call to multiple handsets, the originating handset can end the PTT call. If any one of the destination handsets leaves the PTT call, the call continues until all participants or the initiator hangs up.







To end or leave a PTT call:

Press **OFF** or place the handset in the telephone base or charger. The handset displays **Push to talk Ended**.







note After **PUSH TO TALK** is released, the PTT call remains open for a short time. If no one presses **PUSH TO TALK** within 10 seconds, the PTT call ends automatically.

Answer an incoming call during a PTT call

When you receive an incoming outside call during a PTT session, there is an alert tone. The PTT screen and the caller ID information display alternately.

- During a one-to-one PTT, press  or  on the originating or destination handset. The PTT call ends automatically and the outside call is answered.
- During a PTT call to multiple handsets, press  or  on the originating handset. The PTT call ends automatically and the outside call is answered.
- During a PTT call to multiple handsets, press  or  on any one of the destination handsets and that handset answers the outside call. The PTT call continues for the rest of the PTT participants.
- To leave the PTT call without answering the incoming call, press **OFF**. The telephone continues to ring.

Make an outgoing call during a PTT call

- During a one-to-one PTT call, press  or  to get a dial tone. The PTT call ends automatically.
- During a PTT call to multiple handsets, press  or  on the originating handset. The PTT call ends automatically and you get a dial tone.
- During a PTT call to multiple handsets, press  or  on any one of the destination handsets and that handset gets a dial tone. The PTT call continues for the rest of the PTT participants.

Directory

About the directory

The directory stores up to 50 entries with up to 30 digits for each phone number and 15 characters for each name.

- Directory entries are shared by the handsets. Any modifications made on one device apply to all system devices.
- When you access the directory without records, the screen shows **Directory empty Add contact?**
- When the directory is full and you try to save an entry, the screen shows **Directory full**.
- When you try to save an entry already stored in the directory, the screen shows **Number already saved**.
- Only one system device can review the directory at a time. When a device tries to enter the directory while another device is already in it, **Not available at this time** displays.

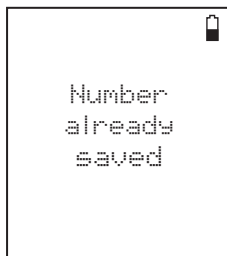

Directory

Add a directory entry

1. Press **MENU** when the phone is not in use.
2. Press **▼** or **▲** to scroll to **Directory**, then press **SELECT**.
3. Press **▼** or **▲** to scroll to **Add contact**, then press **SELECT**.
4. When **ENTER NUMBER** displays, use the dialing keys to enter a number (up to 30 digits).
 - Press **▼** or **▲** to move the cursor to the left or right.
 - Press **DELETE** or **BACKSP** to erase a digit.
 - Press and hold **DELETE** to erase all digits.
 - Press and hold **PAUSE** to enter a dialing pause (a **P** appears).

-OR-

Copy a number from the redial list by pressing **REDIAL**. Then press **▼**, **▲** or **REDIAL** repeatedly to find the desired number. Press **INSERT** to copy the number.

5. Press **NEXT** to move on to the name.
6. When **ENTER NAME** displays, use the dialing keys to enter a name (up to 15 characters). Each time you press a key, the character on that key appears. Additional key presses produce other characters on that key. Press the key repeatedly until the desired character appears. The first character of every word is capitalized.
 - Press **▼** or **▲** to move the cursor to the left or right.
 - Press **0** to add a space.
 - Press **DELETE** or **BACKSP** to erase a character.
 - Press and hold **DELETE** to erase all characters.
7. Press **SAVE** to save. The handset displays **Saved** and then returns to the previous menu. You hear a confirmation tone.



Directory

Add a directory entry

-OR-

1. Use the dialing keys to enter a number (up to 30 digits) when the phone is not in use. Press **SAVE**. The handset displays **EDIT NUMBER**.

- Press **▼** or **▲** to move the cursor to the left or right.
- Press **DELETE** or **BACKSP** to erase a digit.
- Press and hold **DELETE** to erase all digits.
- Press and hold **PAUSE** to enter a dialing pause (a **P** appears).

-OR-

Copy a number from the redial list by pressing **REDIAL**. Then **▼**, **▲** or **REDIAL** repeatedly to find the desired number. Press **SAVE** to copy the number.



2. Press **NEXT** to move on to the name.
3. When **ENTER NAME** displays, use the dialing keys to enter a name (up to 15 characters). Each time you press a key, the character on that key appears. Additional key presses produce other characters on that key. Press the key repeatedly until the desired character appears. The first character of every word is capitalized.
 - Press **▼** or **▲** to move the cursor to the left or right.
 - Press **0** to add a space.
 - Press **DELETE** or **BACKSP** to erase a character.
 - Press and hold **DELETE** to erase all characters.
4. Press **SAVE** to save. The handset displays **Saved** and you hear a confirmation tone.







Directory

Review directory entries

Directory entries appear alphabetically.

1. Press  on the handset when the phone is not in use. The screen displays **Directory Entries: XX** for a few seconds, then displays the first entry in the directory.
2. Press  or  to browse through the directory.

-OR-

1. Press **MENU** when the phone is not in use.
2. Press  or  to scroll to **Directory**, then press **SELECT**.
3. Press **SELECT** to choose **Review**.
4. Press  or  to browse through the directory.







Alphabetical search

You can only perform an alphabetical search on the handset.

1. Press  on the handset when the phone is not in use.



-OR-

- i. Press **MENU** when the phone is not in use.
 - ii. Press  or  to scroll to **Directory**, then press **SELECT**.
 - iii. Press **SELECT** to choose **Review**.
2. Use the dialing keys to enter the letter associated with the name. For example, if you have the entries named Jennifer, Jessie, Kevin and Linda in your directory, press **5** (JKL) once to see Jennifer (when **Jennifer** displays, press  to see **Jessie**), twice to see Kevin, or three times to see Linda. If there is no name entry matching your search, the next closest entry or the last entry in the directory displays on the screen. If necessary, press  or  to browse.



Directory

Dial a directory entry

1. Search for the desired entry in the directory (see **Review directory entries** or **Alphabetical search** on page 65).
2. To dial the displayed entry on the cordless handset, press  or .

Edit a directory entry

1. Search for the desired entry in the directory (see **Review directory entries** or **Alphabetical search** on page 65).
2. When the desired entry displays, press **EDIT**. The handset displays **EDIT NUMBER**.
3. Use the dialing keys to edit the name.
 - Press **▼** or **▲** to move the cursor to the left or right.
 - Press **DELETE** or **BACKSP** to erase a digit.
 - Press and hold **DELETE** to erase all digits.
 - Press and hold **PAUSE** to enter a dialing pause (a **P** appears).
4. Press **NEXT**. The handset displays **EDIT NAME**. Use the dialing keys to edit the number.
 - Press **▼** or **▲** to move the cursor to the left or right.
 - Press **DELETE** or **BACKSP** to erase a character.
 - Press and hold **DELETE** to erase all characters.
5. Press **SAVE** to save the entry. The handset displays **Saved** and then the revised entry. You hear a confirmation tone.



Delete a directory entry

1. Search for the desired entry in the directory (see **Review directory entries** or **Alphabetical search** on page 65).
2. Press **DELETE** on the handset. The handset displays the name of the entry and **Delete contact?**
3. Press **YES** to confirm. The handset displays **Contact deleted**. The handset returns to the previous menu and you hear a confirmation tone.

Directory

Speed Dial

You can assign nine of your directory entries to the speed dial locations (**0** and **2-9**) so that you can dial these numbers more quickly. The speed dial entries are shared by all devices. Changes made to the speed dial entries on one handset apply to all devices.

Assign a speed dial slot

1. Press **MENU** when the phone is not in use.
2. Press **▼** or **▲** to scroll to **Directory**, then press **SELECT**.
3. Press **▼** or **▲** to scroll to **Speed dial**, then press **SELECT**.
4. Press **▼** or **▲**, or a dialing key (**0** or **2-9**) to choose the desired speed dial location.
5. Press **ASSIGN** to show the directory.
6. Press **▼** or **▲** to browse to the desired entry.

-OR-

Use the alphabetical search to find the desired entry (page 65).

7. Press **ASSIGN** to save. The name (up to 12 characters) appears in the selected speed dial location.

note

If the directory is empty when you press **ASSIGN** in Step 5, the handset shows **Directory empty Add contact?**.



Directory

Reassign a speed dial slot

1. Press **MENU** when the phone is not in use.
2. Press **▼** or **▲** to scroll to **Directory**, then press **SELECT**.
3. Press **▼** or **▲** to scroll to **Speed dial**, then press **SELECT**.
4. Press **▼** or **▲**, or a dialing key (**0** or **2-9**) to choose an occupied speed dial location, then press **VIEW**.
5. Press **▼** or **▲** to browse to the desired entry.
-OR-



Use the alphabetical search to find the desired entry (page 65).

6. Press **REPLACE** when the desired entry appears.
7. The handset displays **Entry B replaces Entry A Accept?** Press **YES** to confirm. You hear a confirmation tone.



Dial a speed dial number

- When the phone is not in use, press and hold a dialing key (**0** or **2-9**) to dial the number stored in the corresponding location.

note

When the speed dial location is empty, the handset shows the speed dial list. See **Assign a speed dial slot** on page 67 to add a new entry.

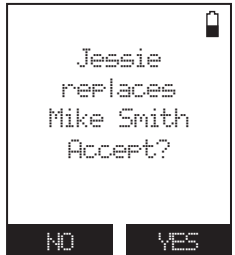

Delete a speed dial entry

1. Press **MENU** when the phone is not in use.
2. Press **▼** or **▲** to scroll to **Directory**, then press **SELECT**.
3. Press **▼** or **▲** to scroll to **Speed dial**, then press **SELECT**.
4. Press **▼** or **▲**, or a dialing key (**0** or **2-9**) to choose the desired speed dial location.
5. Press **DELETE** or **DELETED**. The handset displays **Delete Entry A speed dial assignment?** press **YES**. You hear a confirmation tone.

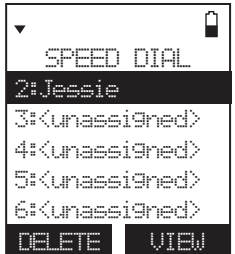

note

Deleting the speed dial entries does not affect the entries in the directory.



Caller ID

About caller ID

This product supports caller ID services offered by most telephone service providers. Depending on your service subscription, you may see the caller's number, or the caller's name and number that are sent by your telephone service provider after the first or second ring. Caller ID allows you to see the name, number, date and time of calls.

Information about caller ID with call waiting

Caller ID with call waiting lets you see the name and telephone number of the caller before answering the call, even while on another call.

It may be necessary to change your telephone service to use this feature. Contact your telephone service provider if:

- You have both caller ID and call waiting, but as separate services (you may need to combine these services).
- You have only caller ID service, or only call waiting service.
- You do not subscribe to caller ID or call waiting services.

There are fees for caller ID services. In addition, services may not be available in all areas.

This product can provide information only if both you and the caller are in areas offering caller ID service and if both telephone service providers use compatible equipment. The time and date, along with the call information, are from the telephone service provider.

Caller ID information may not be available for every incoming call. Callers may intentionally block their names and/or telephone numbers. To view caller ID log entries with numbers between 16 and 24 digits, you must save the entry to the directory (see page 73).

You can use this product with regular caller ID service, or you can use this product's other features without subscribing to caller ID or combined caller ID with call waiting service.

Caller ID

Caller ID log

If you subscribe to caller ID service, information about each caller will appear after the first or second ring. If you answer a call before the caller's information appears, it will not be saved in the caller ID log.

- The caller ID log stores up to 50 entries. Each entry can hold up to 24 digits for the phone number and 15 characters for the name. If the phone number has more than 24 digits, only the last 24 digits appear. If the name has more than 15 characters, only the first 15 characters are shown and saved in the caller ID log.
- Caller ID log entries are shared by all system devices. Any modifications made on one handset apply to all.
- You can review, redial, and copy an entry into the directory.
- Entries appear in reverse chronological order.
- When the caller ID log is full, the oldest entry is deleted to make room for new incoming call information.
- **XX Missed calls** shows when there are new caller ID log entries that have not been reviewed.
- **Caller ID log empty** shows when you access the caller ID log without records.
- Only one system device can review the caller ID log at a time. If a system device tries to enter the caller ID log while another system device is already in it, its screen displays **Not available at this time**.

Memory match

If the incoming telephone number matches the last seven digits of a telephone number in your directory, the name that appears on the screen matches the corresponding name in your directory.

For example, if Mike Smith calls, his name appears as **Mike** if this is how you entered it into your directory.

note The number shown in the caller ID log will be in the format sent by the telephone service provider. The telephone service provider usually delivers 10-digit phone numbers (area code plus telephone number). If the phone number of the caller does not match a number in your directory, the name will appear as it is delivered by the telephone service provider.

Caller ID

Missed call indicator

When there are calls that have not been reviewed in the caller ID log, the screens display **XX Missed calls**. When you have reviewed all the missed calls, the missed call indicator goes away.

Each time you review a caller ID log entry marked **NEW** on the handset, the number of missed calls decreases by one.

If you do not want to review the missed calls one by one, press and hold **CANCEL** on the handset when not in use to clear the missed call indicator. All the entries are then considered old and kept in the caller ID log.



Review the caller ID log

Review the caller ID log to find out who called, to return the call, or to copy the caller's name and number into your directory.

1. Press **CID** on the handset when the phone is not in use. The screen displays **Caller ID log Entries: XX** for a few seconds.
2. Press ▼ or ▲ on the handset to browse.

-OR-

1. Press **MENU** on the handset when the phone is not in use.
2. Press ▼ or ▲ to scroll to **Caller ID log**, then press **SELECT**.
3. Press **SELECT** to choose **Review**.
4. Press ▼ or ▲ to browse. You hear a double beep when the list reaches the beginning or end of the caller ID log.



Caller ID

View dialing options

Although the caller ID log entries received have 10 digits (the area code plus the seven-digit number), in some areas, you may need to dial only the seven digits, or 1 plus the seven digits, or 1 plus the area code plus the seven digits. You can change the number of digits that you dial from the caller ID log and store the new number to the directory.

While reviewing the caller ID log, press **#quiet** (pound key) on the handset repeatedly to display different dialing options for local and long distance numbers before dialing or saving the telephone number in the directory.

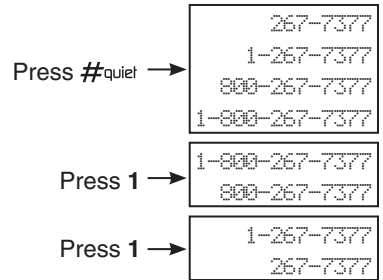

Press **1** repeatedly if you need to add or remove 1 in front of the telephone number before dialing or saving it in the directory.

When the number is displayed in the correct format for dialing, press **TALK** or **■** on a handset to dial.







Caller ID

Dial a caller ID log entry

1. Search for the desired caller ID log entry (see **Review the caller ID log** on page 71).
2. When the desired entry displays, press  or  on a handset to dial.

Save a caller ID log entry to the directory

1. Use the handset to search for the desired caller ID log entry (see **Review the caller ID log** on page 71).
2. When the desired entry displays, press **SAVE**. Then the handset displays **EDIT NUMBER**.
3. Use the dialing keys to edit the number.
 - Press  or  to move the cursor to the left or right.
 - Press **DELETE** or **BACKSP** to backspace and erase a digit.
 - Press and hold **DELETE** to erase the entire entry.
 - Press and hold **PAUSE** to insert a dialing pause (a **P** appears).
4. Press **NEXT** to move to the name. The handset displays **EDIT NAME**.
5. Use the dialing keys to add or edit the name.
 - Press  or  to move the cursor to the left or right.
 - Press **DELETE** or **BACKSP** to erase a character.
 - Press and hold **DELETE** to erase all characters.
 - Press **#quiet** to toggle the name order. For example, Mike Smith becomes Smith Mike when you press **#quiet**.
6. Press **SAVE** when done and the handset shows **Saved**.



note

- If the new directory has the same number as an existing directory entry, the handset displays **Number already save** and returns to previous screen.
- When you try to save a caller ID entry without any caller ID information, the handset displays **Unable to save**.

Caller ID

Delete caller ID log entries

To delete one entry:

1. Search for the desired caller ID log entry (see **Review the caller ID log** on page 71).
2. Press **DELETE** on the handset to delete the displayed entry.

To delete all entries:

1. Press **MENU** when the phone is not in use.
2. Press **▼** or **▲** to scroll to **Caller ID log**, then press **SELECT**.
3. Press **▼** or **▲** to scroll to **Del all calls**, then press **SELECT**.
4. When the screen shows **Delete all calls?**, press **YES** to delete all caller ID log entries. You hear a confirmation tone.



Caller ID log screen messages

Displays:	When:
Private name	The caller is blocking the name.
Private number	The caller is blocking the telephone number.
Private caller	The caller is blocking the name and number.
Unknown name	This caller's name is unavailable.
Unknown number	This caller's number is unavailable.
Unknown caller	No information is available about this caller.
Long distance or L (before the caller's number)	It is a long distance call.

Answering system settings

Answering system

Use the answering system menu of a cordless handset to turn on or off the answering system or message alert tone, set up the announcement message, activate the call screening, or change the number of rings, remote access code or message recording time.

Announcement

The telephone is preset with a greeting that answers calls with, *“Hello. Please leave a message after the tone.”* You can use this preset announcement, or replace it with your own.

Record your own announcement

You can record an announcement up to 90 seconds, but any announcement shorter than two seconds will not be recorded.

1. Press **MENU** when the phone is not in use.
2. Press **▼** or **▲** to scroll to **AnsweringSys**, then press **SELECT**.
3. Press **SELECT** again to select **Announcement**.
4. The handset displays **ANNOUNCEMENT** and announces, *“Announcement. Press **PLAY** or press **RECORD**.”*
5. Press **RECORD** to record an announcement. The system displays **Recording announcement...** and announces, *“Record after the tone. Press **STOP** when you are done.”*
6. After the tone, speak towards the microphone.
7. Press **STOP** when done. The handset plays back the recorded announcement. Press **STOP** to stop the playback at any time. After the announcement playback, you may press **PLAY** to replay the recorded announcement, or **RECORD** to record again if desired.

note

- Your announcement can be up to 90 seconds in length.
- Announcements shorter than two seconds will not be recorded.

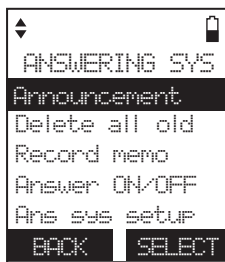

Answering system settings

Play your announcement

1. Press **MENU** when the phone is not in use.
2. Press **▼** or **▲** to scroll to **AnsweringSys**, then press **SELECT**.
3. Press **SELECT** again to choose **Announcement**.
4. The handset displays **ANNOUNCEMENT** and announces, "Announcement. Press **PLAY** or press **RECORD**."
5. Press **PLAY** to play the current announcement.

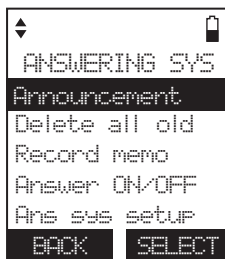

Delete your announcement

1. Press **MENU** when the phone is not in use.
2. Press **▼** or **▲** to scroll to **AnsweringSys**, then press **SELECT**.
3. Press **SELECT** again to choose **Announcement**.
4. The handset displays **ANNOUNCEMENT** and announces, "Announcement. Press **PLAY** or press **RECORD**."
5. Press **PLAY** and then press **RESET** or **DELETE** to delete your recorded announcement. The handset displays **Reset Announcement to default?** Press **YES** to confirm. You hear a confirmation tone.



note

When your announcement is deleted, calls are answered with the default announcement.



Answering system settings

Answer on/off

If you turn the answering system on, it answers calls and records messages.

If your answering system is turned off and you change any of its settings, the answering system automatically turns on and the handset displays **Calls will be answered**.

The answering system must be turned on to answer and record messages. When the answering system is turned on, the **ANS ON/OFF** light on the telephone base turns on and **ANS ON** displays on the handset.

To turn on or off at the telephone base:

- Press **ANS ON/OFF** to turn the answering system on or off. When the answering system is turned on, it announces, *“Calls will be answered.”* When the answering system is turned off, it announces, *“Calls will not be answered.”*

To turn on or off at the handset:

1. Press **MENU** when the phone is not in use.
2. Press **▼** or **▲** to scroll to **AnsweringSys**, then press **SELECT**.
3. Press **▼** or **▲** to scroll to **Answer ON/OFF**, then press **SELECT**.
4. Press **▼** or **▲** to choose **On** or **Off**, then press **SET** to confirm. You hear a confirmation tone.

note

- If there is no memory capacity left on your answering system when you turn it on with the telephone base, **Calls will not be answered**. **Memory full** displays on the handset. The answering system cannot be turned on and it announces, *“Memory is full. Calls will not be answered.”*
- If the remaining recording time is less than three minutes when you turn the answering system on, the telephone announces, *“Calls will be answered. Less than three minutes to record.”* and the handset displays **Rec mem low**.

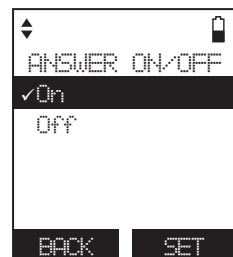
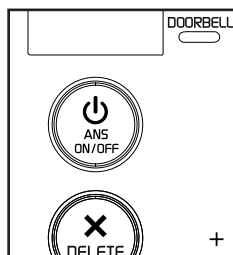

Answering system settings

Call screening

Use this feature to choose whether incoming messages can be heard on while they are being recorded.

1. Press **MENU** when the phone is not in use.
2. Press **▼** or **▲** to scroll to **AnsweringSys**, then press **SELECT**.
3. Press **▼** or **▲** to scroll to **Ans sys setup**, then press **SELECT**.
4. Press **SELECT** to select **Call screening**.
5. Press **▼** or **▲** choose **On** or **Off**.
6. Press **SET** to save and you hear a confirmation tone.



Number of rings

You can set the answering system to answer an incoming call after two, three, four, five or six rings; or toll saver. With toll saver selected, the answering system answers after two rings if you have new messages, or after four rings if there are no new messages. This enables you to check for new messages and avoid paying long distance charges when calling from out of your local area.

1. Press **MENU** when the phone is not in use.
2. Press **▼** or **▲** to scroll to **AnsweringSys**, then press **SELECT**.
3. Press **▼** or **▲** to scroll to **Ans sys setup**, then press **SELECT**.
4. Press **▼** or **▲** to scroll to **# of rings**, then press **SELECT**.
5. Press **▼** or **▲** to choose **6, 5, 4, 3, 2** or **Toll saver**.
6. Press **SET** to save and you hear a confirmation tone.



note

If you subscribe to voicemail service from your telephone service provider, see **Answering system and voicemail** on page 81.

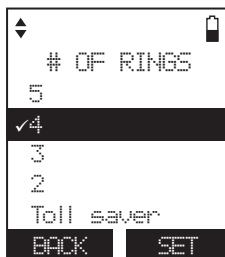
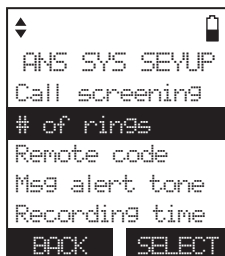

Answering system settings

Remote access code

A two-digit security code is required to access the answering system remotely from any touch-tone telephone. The preset code is **19**. You can set the code from **00** to **99**.

1. Press **MENU** when the phone is not in use.
2. Press ▼ or ▲ to scroll to **AnsweringSys**, then press **SELECT**.
3. Press ▼ or ▲ to scroll to **Ans sys setup**, then press **SELECT**.
4. Press ▼ or ▲ to scroll to **Remote code**, then press **SELECT**.
5. Use the dialing keys to enter a two-digit number.
 - Press ▼ or ▲ to move the cursor to the left or right.
 - Press **DELETE** or **BACKSP** to erase a digit.
 - Press and hold **DELETE** to erase all digits.
6. Press **SAVE** to save and you hear a confirmation tone.

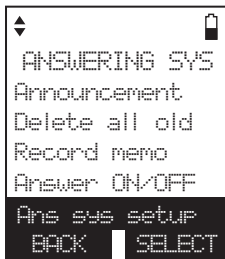

Message alert tone

When the message alert tone is set to on, and there is at least one new message, the telephone base beeps every 10 seconds. There is no audible alert at the handset. The message alert tone is preset to off.

1. Press **MENU** when the phone is not in use.
2. Press ▼ or ▲ to scroll to **AnsweringSys**, then press **SELECT**.
3. Press ▼ or ▲ to scroll to **Ans sys setup**, then press **SELECT**.
4. Press ▼ or ▲ to scroll to **Msg alert tone**, then press **SELECT**.
5. Press ▼ or ▲ to choose **On** or **Off**.
6. Press **SET** to save and you hear a confirmation tone.



note

The answering system must be turned on for the message alert tone to be functional.



Answering system settings

Recording time

You can set the recording time limit for each incoming message. The recording time is preset to three minutes.

1. Press **MENU** when the phone is not in use.
2. Press ▼ or ▲ to scroll to **Answering sys**, then press **SELECT**.
3. Press ▼ or ▲ to scroll to **Ans sys setup**, then press **SELECT**.
4. Press ▼ or ▲ to scroll to **Recording time**, then press **SELECT**.
5. Press ▼ or ▲ to choose **3 minutes**, **2 minutes** or **1 minute**.
6. Press **SET** to save and you hear a confirmation tone.

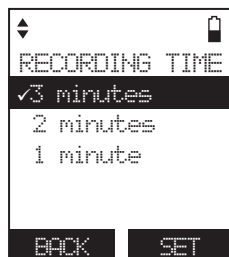
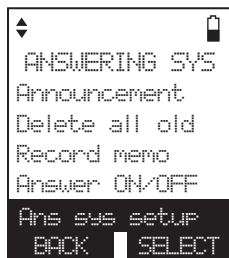

Answering system operation

Answering system and voicemail

Your telephone has separate indicators for two different types of voice messages: those left on its built-in digital answering system and those left with your telephone service provider's voicemail (fees may apply). Your telephone's built-in digital answering system messages and voicemail messages are separate. Each alerts you to new messages differently.

- If **OO** and **XX new msgs** display on the handset and the message window on the telephone base flashes, there are new messages in the built-in answering system. To listen to the messages recorded on your digital answering system, press **▶/■/PLAY/STOP** on the telephone base. To listen to messages with a handset, see **To play messages on the handset** on page 83.
- If **✉** and **New voicemail** display on the handset, your telephone service provider is indicating that it has new voicemail for you. To listen to your voicemail, press and hold 1 **✉** on your handset. See **Voicemail number** on page 38 to set your voicemail number.

Some telephone service providers bundle or combine multiple services like voicemail and call waiting, so you may not be aware that you have voicemail. To check what services you have and how to access them, contact your telephone service provider.

To use your voicemail service rather than your answering system, turn off your answering system. To use your answering system rather than your voicemail service, contact your telephone service provider to deactivate your voicemail service.

Using the answering system and voicemail together

You can also use your telephone answering system and voicemail together by setting your built-in answering system to answer before voicemail answers as described below. To learn how to program your voicemail settings, contact your telephone service provider. Then, if you are on a call, or if the answering system is busy recording a message and you receive another call, the second caller can leave a voicemail message.

Set your answering system to answer calls at least two rings earlier than your voicemail is set to answer. For example, if your voicemail answers after six rings, set your answering system to answer after four rings. Some voicemail providers may program the delay before answering calls in seconds instead of rings. In this case, allow six seconds per ring when determining the appropriate setting.

Answering system operation

Message capacity

The answering system can record and store up to 99 messages. Each message can be up to three minutes in length, depending on the recording time set (see page 80). The total storage capacity for the announcement, messages and memos is approximately 11 minutes. The actual recording time depends on individual message characteristics. Messages remain available for replay until you delete them.

When **F** and the number of messages are flashing alternately on the message window and the handsets display **Rec mem full**, the memory is full. You cannot turn on the answering system and record new messages until some old messages have been deleted.

New message indication

The message window on the telephone base flashes and **oo** and **XX new msgs** displays on the handset when there are new answering system messages.

If the message alert tone is turned on, the telephone base beeps every 10 seconds when there are messages that have not been reviewed.



Answering system operation

Call screening

To screen a call at the telephone base:

If the answering system and call screening are on, the announcement and the incoming message broadcast at the telephone base while the call is answered by the answering system.

Options while a message is being recorded:

- Press **+VOL** or **VOL-** to adjust the call screening volume.
- Press **+VOL** to temporarily turn on the call screening if the call screening is set to off.
- Press **▶/■/PLAY/STOP** to temporarily turn on or off the call screening.

To screen a call at the handset

If the answering system is on and recording a message, press **SCREEN** to screen the call on your handset and the screen displays the caller ID information. If you do not subscribe to caller ID service, the handset shows **Incoming call**.



Options while a message is being recorded:

- Press **VOL-** or **VOL+** to adjust the call screening volume.
- Press **■** to switch between the speakerphone and the handset earpiece.

Call intercept

If you want to talk to the caller whose message is being recorded, press **TALK** or **■** on the handset.

Temporarily turn off the message alert tone

If the message alert tone is turned on (see page 79), the telephone base beeps every 10 seconds when there are new messages. Pressing any telephone base key (except **■/FIND HANDSET**) temporarily silences the message alert tone.

If you press **X/DELETE** when in idle mode to temporarily turn off the message alert tone, there is a voice prompt directing you to press **X/DELETE** again to delete all old messages. The message alert tone is temporarily off. Only press **X/DELETE** a second time if you wish to erase all old messages in your answering system.

The message alert tone resumes when you receive a new message.

Answering system operation

Message playback

On the telephone base, when playback begins, the total number of old or new messages is announced, and the message window displays the message number currently playing.

On the handset, if you have both new and old messages, you can play either new or old messages. The caller ID information displays on the handset screen when you play messages and you can call back the caller.

Before each message, you hear the day and time of the recording. If the date and time are not set, you hear, *"Time and date not set,"* before playback.

After the last message, you hear, *"End of messages."* and the handset displays **End of messages**.

If the recording time left on the answering system is less than three minutes, you hear, *"Less than three minutes to record."*

If there are no recorded messages, the screen shows **You have: No messages** and you hear, *"You have no messages."*

To play messages at the telephone base:

- Press ►/■/PLAY when the phone is not in use.

Options during playback:

- Press VOL- or VOL+ to adjust the message playback volume.
- Press ►►/SKIP to skip to the next message.
- Press ◀◀/REPEAT to repeat the message. Press ◀◀/REPEAT twice to listen to the previous message.
- Press X/DELETE to delete the playing message.
- Press ►/■/STOP to stop the playback.

Answering system operation

To play messages on the handset:

1. Press **MENU** when the phone is not in use.
2. Press **SELECT** to choose **Play msg.s**. If you have either new or old messages, the messages play automatically. If you have both new and old messages:
 - To play new messages, press **SELECT** to select **Play new msg.s**.
 - To play old messages, press **▼** or **▲** to choose **Play old msg.s**, then press **SELECT**.

When the handset is playing a message, its screen shows the caller's name or number. If the caller's information is unavailable, the handset shows **No caller info**.



Options during playback:

- Press **VOL+** or **VOL-** to adjust the message playback volume.
- Press **SKIP** to skip to the next message.
- Press **REPEAT** to repeat the message. Press **REPEAT** twice to hear the previous message.
- Press **☎** to switch between the speakerphone and the handset earpiece.
- Press **DELETE** to delete the playing message. The handset displays **Message deleted** briefly and the system advances to the next message.
- Press **OFF** to stop the playback.

note

Only one device can access the answering system at a time.

Answering system operation

Delete all old messages

You can only delete old (reviewed) messages. You cannot delete new messages until you review them. You cannot retrieve deleted messages.

To delete all old messages at the telephone base:

1. Press **X/DELETE** when the phone is not in use. You hear, *“To delete all old messages, press X/DELETE again.”*
2. Press **X/DELETE** again. You hear, *“All old messages deleted.”* and a confirmation tone.

To delete all old messages on the handset:

1. Press **MENU** when the phone is not in use.
2. Press **▼** or **▲** to scroll to **AnsweringSys**. Press **SELECT**.
3. Press **▼** or **▲** to scroll to **Delete all old**, then press **SELECT**. The handset shows **Delete all old messages?**
4. Press **YES** to confirm. The handset displays **Deleting...** then **All old messages deleted!** and then returns to the previous menu. You hear a confirmation tone.



Record, play and delete memos

Memos are your own recorded messages used as reminders for yourself or others using the same answering system. You can record your own memos using the handset. Play and delete them in the same way as incoming messages (see **Message playback** on page 84).

To record a memo:

1. Press **MENU** when the phone is not in use.
2. Press **▼** or **▲** to scroll to **AnsweringSys**, then press **SELECT**.
3. Press **▼** or **▲** to scroll to **Record memo**, then press **SELECT**.
4. The system displays **Recording memo...** and announces, *“Record after the tone. Press STOP when you are done.”* After the tone, speak towards the microphone.
5. Press **STOP** to stop recording. The system announces, *“Recorded.”* and then returns to previous menu.



note

- The system announces “Memory is full” and the handset displays Memory full if you record a memo when the memory is full.
- Each memo can be up to four minutes in length.
- Memos shorter than two seconds are not recorded.

Answering system operation

Remote access

A two-digit security code is required to access the answering system remotely from any touch-tone telephone. The preset code is **19**. See **Remote access code** on page 79 to change it.

1. Dial your telephone number from any touch-tone telephone.
2. When the system plays your announcement, enter the two-digit security code.
3. You can enter one of the following remote commands.

Command	Description
1	Play all messages.
2	Play new messages.
3	Delete the current message (during playback).
33	Delete all old messages.
4	Repeat the current message (during playback).
5	Stop.
*5	Hear a list of remote commands.
6	Skip to the next message (during playback).
*7	Record a new announcement.
8	End the call.
0	Turn the answering system on or off.

4. Hang up or press **8** to end the call.

- note**
- If you do not press any keys after you enter the remote access code, all new messages play. If there are no new messages, all old messages play.
 - Once the new messages have played, the telephone announces the help menu options. If you do not press any key within 20 seconds, the remote access call automatically disconnects.
 - When the answering system is turned off, the telephone answers after 10 rings, and announces, *"Please enter your remote access code."*
 - When the answering system memory is full, the telephone announces, *"Memory is full. Enter the remote access code."*

Appendix

Expand your telephone system

You can add new handsets (**IS7101**, purchased separately) and new doorbell (**IS741**, purchased separately) to your telephone system. This telephone system accommodates up to 12 devices, including a maximum of two doorbells.

For more details, refer to the user's manual that comes with your **IS7101** new handset and **IS741** new doorbell respectively.

Appendix

Screen messages

Area code will not show in Caller ID log	The home area code you saved will not be shown in caller ID log.
Caller ID log empty	There are no caller ID log entries.
Caller ID won't be announced.	The ringer volume on the handset is turned off so no caller ID information will be announced for incoming calls.
Calling all handsets (for models with more than two handsets)	The handset is calling all system handsets.
Calling HANDSET X	You are calling another handset.
Call transferred	You have successfully transferred an outside call to another handset.
Contact deleted	A directory entry is deleted.
Directory empty	There are no directory entries.
Directory full	The directory is full. You cannot save any new entries unless you delete some current entries.
Ended	You have just ended a call.
Handset X is calling	Another system handset is calling (for intercom calls).
Incoming call	There is an coming call.
Intercom	The system device is on an intercom call.
Intercom ended	The intercom call has just ended.
INTERCOM TO:	You have started the intercom process, and need to enter the number of the system device you wish to call.
Line in use	A system device or another telephone on the same line is in use.
Low battery	The handset battery needs to be recharged.
Microphone off	The microphone is off. The other party cannot hear you.
Microphone on	The mute function is turned off and the other party can hear you.
New voicemail	There are new voicemail messages from your telephone service provider.
No answer. Try again.	You tried to make an intercom call, but the handset you are calling is busy or out of range.

Appendix

Screen messages

No battery	The handset in the telephone base or charger has no battery installed.
No line	There is no telephone line connection.
No PTT call	The incoming PTT function is disabled. The handset will not receive PTT calls.
Not available at this time	Someone else is using the directory, caller ID log, or answering system.
Number already saved	The telephone number you have entered is already in the directory.
Out of range OR No power at base	The telephone base has lost power, or the handset is out of range.
Place in charger	The battery is very low. Put the handset in the telephone base for recharging.
PTT From HANDSET X To HANDSET Y	One handset has started a PTT session to another handset.
PTT To HANDSET X	You have started the PTT process.
Push to talk Ended	The PTT session is ended.
Rec mem full	The system recording time is full.
Registration failed	The handset fails to register to the telephone base.
Ringer muted	The ringer is off temporarily during an incoming call.
Ringer off	The ringer is turned off.
Saved	Your selection has been saved.
Speaker	The speakerphone is in use.
Unable to call. Try again.	The handset is out of range while on a call. Failed phone call (the telephone line is in use). Failed intercom or conference call (there are already two handsets being used).
Unable to save	You tried to save a caller ID entry with no caller ID information.
XX Missed calls	There are new calls in the caller ID log.
XX new messages	There are new messages in the answering system.
XXX new pics	There are new photos in the photo log.
** Paging **	The telephone base is paging the handset.

Appendix

Handset and telephone base indicators











Telephone base lights

ANS ON/OFF	On when the answering system is turned on.
IN USE	On when the telephone line is in use.
DOORBELL	Flashes when  DOORBELL is pressed.

Handset lights

CHARGE	On when the handset is charging in the telephone base or charger.
	On when the handset speakerphone is in use.

Handset icons

	The battery icon flashes when the battery is low and needs charging.
	The battery icon animates when the battery is charging.
	The battery icon becomes solid when the battery is fully charged.
	The video signal icon indicates the strengthness of the video signal reception during the video streaming session. Icon with three bars indicates the best signal reception.
	The doorbell is ringing.
	The handset ringer is off.
	There are new messages recorded by the answering system.
	There are new voicemail received from the telephone service provider.
ANS ON	The answering system is turned on.
	The speakerphone is active.
	The ISO icon indicates the ISO profile during video streaming.
	The zoom feature is in use during video streaming.

Appendix

Battery

It takes up to 11 hours for the battery to be fully charged. When it is fully charged, you can expect the following performance:

Operation	Operating time
While in handset use (talking*)	Up to seven hours
While in speakerphone mode (talking*)	Up to three hours
While not in use (standby**)	Up to five days

* Operating times vary depending on your actual use and the age of the battery.

** Handset is not charging or in use.

The battery needs charging when:

- A new battery is installed in the handset.
- A battery is properly installed and the screen is blank.
- **Low battery** or **Put in charger** displays on the handset screen.

CAUTION:

To reduce the risk of fire or injury, read and follow these instructions:

- Use only the batteries provided or equivalent. To order a replacement, visit our website at www.vtechcanada.com or call 1 (800) 267-7377.
- Do not dispose of the batteries in a fire. Check with local waste management codes for special disposal instructions.
- Do not open or mutilate the batteries. Released electrolyte is corrosive and may cause burns or injury to the eyes or skin. The electrolyte may be toxic if swallowed.
- Exercise care in handling batteries in order not to create a short circuit with conductive materials.
- Charge the batteries provided with or identified for use with this product only in accordance with the instructions and limitations specified in this manual.
- Observe proper polarity orientation between the battery and metallic contacts.
- To prevent fire or shock hazard, do not expose this product to water or any type of moisture.

Appendix

Troubleshooting

If you have difficulty with your telephone, please try the suggestions below. For customer service, visit our website at www.vtechcanada.com or call 1 (800) 267-7377.

My telephone doesn't work at all.

- Make sure the power cord is securely plugged in.
- Make sure you plug the battery connector securely into the cordless handset.
- Make sure you plug the telephone line cord securely and firmly into the telephone base and the telephone wall jack.
- Unplug the electrical power to the telephone base. Wait for approximately 15 seconds, then plug it back in. Allow up to one minute for the cordless handset and telephone base to synchronize.
- Charge the battery in the cordless handset for up to 11 hours.
- If the battery is completely depleted, charge the handset for at least 30 minutes before use (page 4).
- Reset the telephone base. Unplug the electrical power. Wait for approximately 15 seconds, then plug it back in. Allow up to one minute for the cordless handset and telephone base to reset.
- You may need to purchase a new battery. Please refer to **Handset battery installation** (page 3) and **Handset battery charging** (page 4).
- Disconnect the telephone base from the telephone wall jack and plug in a working telephone. If the other telephone does not work, the problem is probably in the wiring or telephone service. Contact your telephone service provider.

The display shows **No line. I cannot hear the dial tone.**

- Disconnect the telephone line cord from your telephone and connect it to another telephone. If there is no dial tone on that other telephone either, then the telephone line cord may be defective. Try installing a new telephone line cord.
- If changing telephone line cord does not help, the wall jack (or the wiring to this wall jack) may be defective. Contact your telephone service provider.
- You may be using a new cable or VoIP service, the existing telephone jacks in your home may no longer work. Contact your service provider for solutions.



The display shows **Put handset on BASE on register. The handset does not work at all.**

- The handset is deregistered from the telephone base. Place the handset in the telephone base to register it back. The handset shows **HANDSET X Registered** and you hear a beep when the registration process completes. This process takes about 60 seconds to complete.

Appendix

Troubleshooting

The lights on the doorbell flash quickly. The doorbell does not work at all.

- The doorbell is deregistered from the telephone base. Follow the instructions below to register the doorbell back to the telephone base.
 1. **Press and hold**  **FIND HANDSET** on the telephone base for about four seconds until the **IN USE** light turns on.
 2. **Press and hold**  **DOORBELL** for about 10 seconds until the doorbell light flashes slowly.

The doorbell light turns on and you hear a confirmation tone from the doorbell when registration completes. It takes about 60 seconds to complete the registration process.

I cannot dial out.

- Try all the suggestions above.
- Make sure you have a dial tone before dialing. The cordless handset may take a second or two to find the telephone base and produce a dial tone. This is normal. Wait an extra second before dialing.
- Eliminate any background noise. Noise from a television, radio or other appliances might cause the phone to not dial out properly. If you cannot eliminate the background noise, first try muting the cordless handset before dialing, or dialing from another room with less background noise.
- If other phones in your home are having the same problem, contact your telephone service provider (charges may apply).

My cordless handset isn't performing normally.

- Make sure you plug the power cord securely into the telephone base. Plug the power adapter into a different, working electrical outlet without a wall switch.
- Move the cordless handset closer to the telephone base. You may have moved out of range.
- Reset the telephone base. Unplug the electrical power. Wait for 15 seconds then plug it back in. Allow up to one minute for the cordless handset and telephone base to reset.
- Other electronic products such as HAM radios and other DECT phones can cause interference with your cordless phone. Try installing your phone as far away as possible from these types of electronic devices.

Appendix

Troubleshooting

Out of range or No power at base appears on my cordless handset.

- Ensure you plug the telephone base in properly and the power is on.
- Place the cordless handset closer to the telephone base for synchronization.
- Move the cordless handset closer to the telephone base. You may have moved out of range.
- Reset the telephone base. Unplug the electrical power. Wait for 15 seconds then plug it back in. Allow up to one minute for the cordless handset and telephone base to reset.
- Other electronic products such as HAM radios and other DECT phones can cause interference with your cordless phone. Try installing your phone as far away as possible from these types of electronic devices.

The battery does not charge in the handset, or the handset battery does not accept charge.

- If the cordless handset is in the telephone base and the charge light is not on, refer to **The charge light is off** (page 99).
- Charge the battery in the cordless handset for at least 11 hours. For optimum daily performance, return the cordless handset to the telephone base when not in use.
- If the battery is completely depleted, charge the handset for at least 30 minutes before use (page 4).
- You may need to purchase a new battery. Please refer to **Handset battery installation** (page 3) and **Handset battery charging** (page 4).

There is no chime from the doorbell when it is pressed.

- Make sure you install two AA batteries and connect AC power supply to the doorbell.
- The doorbell light on the doorbell flashes when the doorbell is pressed. If the light doesn't flash, the doorbell may have run out of battery. You may need to replace new batteries.
- Make sure the doorbell is registered to the telephone system.



Appendix

Troubleshooting

The handset receives no signal of video streaming when the doorbell is pressed.

- Make sure you install two AA batteries and connect AC power supply to the doorbell.
- Make sure the doorbell is registered to the telephone system.
- Make sure your handset is in reception range and works probably.
- Make sure the chime volume of your handset is not set to off. Refer to **Chime volume** on page 31 in this user's manual.
- If there is an incoming call when the doorbell is pressed, the handset will not respond to the chime.
- Make sure no handset is using Push-to-talk.
- When three or more system handsets are in use for a call at a time, video streaming will be disabled.
- If you have more than one doorbell, make sure the other doorbell is not in use for video streaming. Only one doorbell can be used for video streaming at a time.
- If the previous suggestions do not work, deregister all devices and register them to the telephone base again.

The captured image or video streaming is too bright or too dark.

- If the image is too bright, it may be caused by sunlight reflection. Avoid mounting the doorbell to where it is exposed to direct sunlight or reflections caused by sunlight.
- If the image is too dark, make sure the location where the doorbell is installed has enough exposure to light. If you would like to use the built-in infrared feature for enhanced brightness, make sure the surroundings is dark enough for this feature to be used.
- During video streaming, press  followed by  or  to adjust the brightness level.
- If the previous suggestions do not work, find another location to install the doorbell. Refer to **Locating the doorbell** on pages 10-13 in this user's manual.

I can hear only audio but see no video when I try to perform the video streaming.

- When two handsets in the telephone system are in use for a call, you can only perform audio streaming with the doorbell using other handset(s). To allow video streaming to take place, end the call on either handset or both handsets.

When the handset chimes and I try to answer, it shows Not available at this time.

- Make sure no handset is using intercom.

Appendix

Troubleshooting

I get noise, static, or weak signals even when I'm near the telephone base.

- If you subscribe to high-speed Internet service (DSL - digital subscriber line) through your telephone line, you must install a DSL filter between the telephone line cord and the telephone wall jack (page 2). The filter prevents noise and caller ID problems as a result of DSL interference. Contact your DSL service provider for more information about DSL filters.
- You may be able to improve the performance of your cordless phone by installing your new telephone base as far as possible from any other existing cordless telephone system that may already be installed.
- Other electronic products such as HAM radios and other DECT phones can cause interference with your cordless phone. Try installing your phone as far away as possible from these types of electronic devices.
- Do not install this phone near a microwave oven or on the same electrical outlet. You may experience decreased performance while the microwave oven is operating.
- If you plug your phone in with a modem or a surge protector, plug the phone (or modem/surge protector) into a different location. If this does not solve the problem, relocate your phone or modem farther apart from one another, or use a different surge protector.
- Relocate your phone to a higher location. The phone may have better reception in a high area.
- If other phones in your home are having the same problem, contact your telephone service provider (charges may apply).

I experience poor sound quality when using the handset speakerphone.

- For increased sound quality while using the handset speakerphone, place the handset on a flat surface with the dialing keys facing up.

I hear other calls while using my phone.

- Disconnect the telephone base from the telephone jack, and plug in a different telephone. If you still hear other calls, call your telephone service provider.

Appendix

Troubleshooting

The telephone does not ring when there is an incoming call.

- Make sure that the ringer is not off. Refer to **Handset ringer volume** and **Telephone base ringer volume** on page 30 in this user's manual.
- Make sure you plug in the telephone line cord securely into the telephone base and the telephone jack. Make sure you plug in the power cord securely.
- The cordless handset may be too far from the telephone base.
- Charge the battery in the cordless handset for at least 11 hours. For optimum daily performance, return the cordless handset to the telephone base when not in use.
- You may have too many extension phones on your telephone line to allow all of them to ring simultaneously. Try unplugging some of the other phones.
- The layout of your home or office might be limiting the operating range. Try moving the telephone base to another location, preferably to a higher location.
- If other phones in your home are having the same problem, contact your telephone service provider (charges may apply).
- Test a working phone at the phone jack. If another phone has the same problem, contact your telephone service provider (charges may apply).
- Other electronic products such as HAM radios and other DECT phones can cause interference with your cordless phone. Try installing your phone as far away as possible from these types of electronic devices.
- Remove and install the battery again. Place the cordless handset in the telephone base or charger. Wait for the cordless handset to reestablish its connection with the telephone base. Allow up to one minute for this to take place.
- Your line cord may be defective. Try installing a new line cord.

My calls cut in and out while I'm using my cordless handset.

- Other electronic products such as HAM radios and other DECT phones can cause interference with your cordless phone. Try installing your phone as far away as possible from these types of electronic devices.
- Do not install this phone near a microwave oven or on the same electrical outlet. You may experience decreased performance while the microwave oven is operating.
- If you plug your phone in with a modem or surge protector, plug the phone (or modem/surge protector) into a different location. If this does not solve the problem, relocate your phone or modem farther apart from one another, or use a different surge protector.
- Relocate your telephone base to a higher location. The phone may have better reception when installed in a high area.
- If other phones in your home are having the same problem, contact your telephone service provider (charges may apply).

Appendix

Troubleshooting

The charge light is off.

- Make sure you plug the power and line cords in correctly and securely.
- Unplug the electrical power. Wait for 15 seconds, then plug it back in. Allow up to one minute for the cordless handset and telephone base to reset.
- Clean the charging contacts on the cordless handset and telephone base each month with a pencil eraser or cloth.

My caller ID isn't working properly.

- Caller ID is a subscription service. You must subscribe to this service from your telephone service provider for this feature to work on your phone.
- The caller must be calling from an area that supports caller ID.
- Both your and your caller's telephone service providers must use caller ID compatible equipment.
- If you subscribe to high-speed Internet service (DSL - digital subscriber line) through your telephone line, you must install a DSL filter between the telephone line cord and the telephone wall jack (page 2). The filter prevents noise and caller ID problems resulting from DSL interference. Contact your DSL service provider for more information about DSL filters.

My telephone does not receive caller ID when on a call.

- Make sure you subscribe to caller ID with call waiting features from your telephone service provider. Caller ID feature works only if both you and the caller are in areas offering caller ID service, and if both telephone service providers use compatible equipment.

The messages on the answering system are incomplete.

- If a caller leaves a very long message, part of it may be lost when the system disconnects the call after the preset recording time.
- If the caller pauses for too long, the system stops recording and disconnects the call.
- If memory on the answering system becomes full during a message, the system stops recording and disconnects the call.
- If the caller's voice is very soft, the system may stop recording and disconnect the call.

The messages are very difficult to hear.

- Tap **VOL+** on the telephone base, or press **▲/VOLUME** on the cordless handset to increase the listening volume.

Appendix

Troubleshooting

The answering system does not answer after the correct number of rings.

- Make sure that the answering system is on. **ANS ON** should show on the handset and the telephone base.
- If toll saver is activated, the number of rings changes to two when you have new messages stored (page 78).
- If the memory is full or the system is off, the system will answer after 10 rings.
- In some cases, the answering system is affected by the ringing system used by your telephone service provider.
- If you subscribe to voicemail service, change the number of rings so that your answering system answers before your voicemail answers. To determine how many rings activate your voicemail, contact your telephone service provider.
- If there is a fax machine connected to the same telephone line, try disconnecting the fax machine. If that solves the problem, consult your fax machine documentation for information on compatibility with answering systems.

The telephone does not respond to remote commands.

- Make sure to enter your remote access code correctly (page 87).
- Make sure you are calling from a touch-tone phone. When you dial a number, you should hear tones. If you hear clicks, the phone is not a touch-tone telephone and cannot activate the answering system.
- The answering system may not detect the remote access code while your announcement is playing. Try waiting until the announcement is over before entering the code.
- There may be interference on the phone line you are using. Press dialing keys firmly.

The answering system does not record messages.

- Make sure the answering system is on. **ANS ON** should show on the handset and the telephone base.
- Make sure the memory of the answering system is not full.
- If you subscribe to voicemail service, change the number of rings so that your answering system answers before your voicemail answers. To determine how many rings activate your voicemail, contact your telephone service provider.
- If there is a fax machine connected to the same telephone line, try disconnecting the fax machine. If that solves the problem, consult your fax machine documentation for information on compatibility with answering systems.

Appendix

Troubleshooting

The system announces “*Time and date not set.*”

- You need to reset the system clock (page 33).

The outgoing announcement is not clear.

- When you record your announcement, make sure you speak in a normal tone of voice, about nine inches from the handset or telephone base.
- Make sure there is no background noise (TV, music, etc.) while recording.

New voicemail and show and I don't know why.

- Your telephone has both a built-in answering system and voicemail indication. If **New voicemail** and  appear, then your telephone has received a signal from your telephone service provider that you have a voicemail message waiting for you to retrieve from them. Contact your telephone service provider for more information on how to access your voicemail.

I cannot retrieve voicemail messages.

- Your telephone has both a built-in answering system and voicemail indication. They are independent features and each alerts you to new messages differently. If you subscribe to voicemail service from your telephone service provider, contact your telephone service provider for more information on how to access your voicemail.

I subscribe to a nontraditional telephone service that uses my computer to establish connections, and my telephone doesn't work.

- Make sure your computer is powered on.
- Make sure your Internet connection is working properly.
- Make sure that the software is installed and running for your nontraditional telephone service.
- Make sure to plug your USB telephone adapter into a dedicated USB port on your computer. Do not plug into a multiple port USB hub (USB splitter) that is not powered.
- In a few rare instances, the USB port on your computer may not have enough power. In these instances, try using a USB hub with its own external power supply.
- If you are using a firewall, it may prevent access to your nontraditional telephone service provider. Contact your service provider for more information.

I accidentally changed the LCD language to French or Spanish, and I don't know how to change it back to English.

- While the handset is in idle mode, press **MENU** and then enter ***364#**.
- While the handset is on a call, press **MENU** and then enter ***364#**. Then press **OFF** to exit the menu.

Appendix

Troubleshooting

Common cure for electronic equipment.

If the telephone does not seem to be responding normally, do the following (in the order listed):

1. Disconnect the power to the telephone base.
2. Disconnect the cordless handset battery.
3. Wait a few minutes.
4. Connect power to the telephone base.
5. Install the battery again, and place the cordless handset in the telephone base.
6. Wait for the cordless handset to reestablish its connection with the telephone base.
Allow up to one minute for this to take place.

Appendix

Important safety instructions

When using your telephone equipment, basic safety precautions should always be followed to reduce the risk of fire, electric shock and injury, including the following:

1. Read and understand all instructions.
2. Follow all warnings and instructions marked on the product.
3. Unplug this product from the wall outlet before cleaning. Do not use liquid or aerosol cleaners. Use a damp cloth for cleaning.
4. Do not use this product near water such as near a bath tub, wash bowl, kitchen sink, laundry tub or swimming pool, or in a wet basement or shower.
5. Do not place this product on an unstable table, shelf, stand or other unstable surfaces.
6. Avoid placing the telephone system in places with extreme temperature, direct sunlight, or other electrical devices. Protect your phone from moisture, dust, corrosive liquids and fumes.
7. Slots and openings in the back or bottom of the telephone base and handset are provided for ventilation. To protect them from overheating, these openings must not be blocked by placing the product on a soft surface such as a bed, sofa or rug. This product should never be placed near or over a radiator or heat register. This product should not be placed in any area where proper ventilation is not provided.
8. This product should be operated only from the type of power source indicated on the marking label. If you are not sure of the type of power supply in your home or office, consult your dealer or local power company.
9. Do not allow anything to rest on the power cord. Do not install this product where the cord may be walked on.
10. Never push objects of any kind into this product through the slots in the telephone base or handset because they may touch dangerous voltage points or create a short circuit. Never spill liquid of any kind on the product.
11. To reduce the risk of electric shock, do not disassemble this product, but take it to an authorized service facility. Opening or removing parts of the telephone base or handset other than specified access doors may expose you to dangerous voltages or other risks. Incorrect reassembling can cause electric shock when the product is subsequently used.
12. Do not overload wall outlets and extension cords.
13. Unplug this product from the wall outlet and refer servicing to an authorized service facility under the following conditions:
 - When the power supply cord or plug is damaged or frayed.
 - If liquid has been spilled onto the product.
 - If the product has been exposed to rain or water.
 - If the product does not operate normally by following the operating instructions. Adjust only those controls that are covered by the operation instructions. Improper adjustment of other controls may result in damage and often requires extensive work by an authorized technician to restore the product to normal operation.
 - If the product has been dropped and the telephone base and/or handset has been damaged.
 - If the product exhibits a distinct change in performance.
14. Avoid using a telephone (other than cordless) during an electrical storm. There is a remote risk of electric shock from lightning.
15. Do not use the telephone to report a gas leak in the vicinity of the leak. Under certain circumstances, a spark may be created when the adapter is plugged into the power outlet, or when the handset is replaced in its cradle. This is a common event associated with the closing of any electrical circuit. The user should not plug the phone into a power outlet, and should not put a charged handset into the cradle, if the phone is located in an environment containing concentrations of flammable or flame-supporting gases, unless there is adequate ventilation. A spark in such an environment could create a fire or explosion. Such environments might include: medical use of oxygen without adequate ventilation; industrial gases (cleaning solvents; gasoline vapors; etc.); a leak of natural gas; etc.
16. Only put the handset of your telephone next to your ear when it is in normal talk mode.

Appendix

Important safety instructions

17. The power adapters are intended to be correctly oriented in a vertical or floor mount position. The prongs are not designed to hold the plug in place if it is plugged into a ceiling, under-the-table or cabinet outlet.

SAVE THESE INSTRUCTIONS

Precautions for users of implanted cardiac pacemakers

Cardiac pacemakers (applies only to digital cordless telephones):

Wireless Technology Research, LLC (WTR), an independent research entity, led a multidisciplinary evaluation of the interference between portable wireless telephones and implanted cardiac pacemakers. Supported by the U.S. Food and Drug Administration, WTR recommends to physicians that:

Pacemaker patients

- Should keep wireless telephones at least six inches from the pacemaker.
- Should NOT place wireless telephones directly over the pacemaker, such as in a breast pocket, when it is turned ON.
- Should use the wireless telephone at the ear opposite the pacemaker.

WTR's evaluation did not identify any risk to bystanders with pacemakers from other persons using wireless telephones.

Operating range

This cordless telephone operates with the maximum power allowed by the Federal Communications Commission (FCC). Even so, this handset and telephone base can communicate over only a certain distance - which can vary with the locations of the telephone base and handset, the weather, and the layout of your home or office.

When the handset is out of range, the handset displays **Out of range OR No power at base**.

If there is a call while the handset is out of range, it may not ring, or if it does ring, the call may not connect well when you press **TALK**. Move closer to the telephone base, then press **TALK** to answer the call.

If the handset moves out of range during a telephone conversation, there may be interference. To improve reception, move closer to the telephone base.

ECO mode

This power conserving technology reduces power consumption for optimal battery performance. The ECO mode activates automatically whenever the handset is synchronized with the telephone base.

Appendix

Maintenance

Taking care of your telephone

Your telephone contains sophisticated electronic parts, so it must be treated with care.

Avoid rough treatment

Place the handset down gently. Save the original packing materials to protect your telephone if you ever need to ship it.

Avoid water

Your telephone can be damaged if it gets wet. Do not use the handset outdoors in the rain, or handle it with wet hands. Do not install the telephone base near a sink, bathtub or shower.

Electrical storms

Electrical storms can sometimes cause power surges harmful to electronic equipment. For your own safety, take caution when using electrical appliances during storms.

Cleaning your telephone

Your telephone has a durable plastic casing that should retain its luster for many years. Clean it only with a dry non-abrasive cloth. Do not use dampened cloth or cleaning solvents of any kind.

Remember that electrical appliances can cause serious injury if used when you are wet or standing in water. If the telephone base should fall into water, DO NOT RETRIEVE IT UNTIL YOU UNPLUG THE POWER CORD AND TELEPHONE LINE CORD FROM THE WALL. Then remove the telephone by the unplugged cords.

Appendix

About cordless telephones

- **Privacy:** The same features that make a cordless telephone convenient create some limitations. Telephone calls are transmitted between the telephone base and the cordless handset by radio waves, so there is a possibility that the cordless telephone conversations could be intercepted by radio receiving equipment within range of the cordless handset. For this reason, you should not think of cordless telephone conversations as being as private as those on corded telephones.
- **Electrical power:** The telephone base of this cordless telephone must be connected to a working electrical outlet. The electrical outlet should not be controlled by a wall switch. Calls cannot be made from the cordless handset if the telephone base is unplugged, switched off or if the electrical power is interrupted.
- **Potential TV interference:** Some cordless telephones operate at frequencies that may cause interference to televisions and VCRs. To minimize or prevent such interference, do not place the telephone base of the cordless telephone near or on top of a TV or VCR. If interference is experienced, moving the cordless telephone farther away from the TV or VCR often reduces or eliminates the interference.
- **Rechargeable batteries:** Exercise care in handling batteries in order not to create a short circuit with conducting material such as rings, bracelets and keys. The battery or conductor may overheat and cause harm. Observe proper polarity between the battery and the battery charger.
- **Nickel-metal hydride rechargeable batteries:** Dispose of these batteries in a safe manner. Do not burn or puncture the battery. Like other batteries of this type, if burned or punctured, they could release caustic material which could cause injury.

The RBRC® seal

The RBRC® seal on the nickel-metal hydride battery indicates that VTech Communications, Inc. is voluntarily participating in an industry program to collect and recycle these batteries at the end of their useful lives, when taken out of service within the United States and Canada.

The RBRC® program provides a convenient alternative to placing used nickel-metal hydride batteries into the trash or municipal waste, which may be illegal in your area.

VTech's participation in RBRC® makes it easy for you to drop off the spent battery at local retailers participating in the RBRC® program or at authorized VTech product service centers. Please call **1 (800) 8 BATTERY®** for information on Ni-MH battery recycling and disposal bans/restrictions in your area. VTech's involvement in this program is part of its commitment to protecting our environment and conserving natural resources.

RBRC® and 1 (800) 8 BATTERY® are registered trademarks of the Rechargeable Battery Recycling Corporation.



Appendix

FCC, ACTA and IC regulations

FCC Part 15

This equipment has been tested and found to comply with the requirements for a Class B digital device under Part 15 of the Federal Communications Commission (FCC) rules. These requirements are intended to provide reasonable protection against harmful interference in a residential installation. This equipment generates, uses and can radiate radio frequency energy and, if not installed and used in accordance with the instructions, may cause harmful interference to radio communications. However, there is no guarantee that interference will not occur in a particular installation. If this equipment does cause harmful interference to radio or television reception, which can be determined by turning the equipment off and on, the user is encouraged to try to correct the interference by one or more of the following measures:

- Reorient or relocate the receiving antenna.
- Increase the separation between the equipment and receiver.
- Connect the equipment into an outlet on a circuit different from that to which the receiver is connected.
- Consult the dealer or an experienced radio/TV technician for help.

Changes or modifications to this equipment not expressly approved by the party responsible for compliance could void the user's authority to operate the equipment.

This device complies with Part 15 of the FCC rules. Operation is subject to the following two conditions: (1) this device may not cause harmful interference, and (2) this device must accept any interference received, including interference that may cause undesired operation. Privacy of communications may not be ensured when using this telephone.

To ensure safety of users, the FCC has established criteria for the amount of radio frequency energy that can be safely absorbed by a user or bystander according to the intended usage of the product. This product has been tested and found to comply with the FCC criteria. The handset may be safely held against the ear of the user. The telephone base shall be installed and used such that parts of the user's body other than the hands are maintained at a distance of approximately 20 cm (8 inches) or more.

This Class B digital apparatus complies with Canadian requirement:
CAN ICES-3 (B)/NMB-3(B).

Appendix

FCC, ACTA and IC regulations

FCC Part 68 and ACTA

This equipment complies with Part 68 of the FCC rules and with technical requirements adopted by the Administrative Council for Terminal Attachments (ACTA). The label on the back or bottom of this equipment contains, among other things, a product identifier in the format US:AAAEQ##TXXXX. This identifier must be provided to your telephone service provider upon request.

The plug and jack used to connect this equipment to premises wiring and the telephone network must comply with applicable Part 68 rules and technical requirements adopted by ACTA. A compliant telephone cord and modular plug is provided with this product. It is designed to be connected to a compatible modular jack that is also compliant. An RJ11 jack should normally be used for connecting to a single line and an RJ14 jack for two lines. See the installation instructions in the user's manual.

The Ringer Equivalence Number (REN) is used to determine how many devices you may connect to your telephone line and still have them ring when you are called. The REN for this product is encoded as the 6th and 7th characters following the US: in the product identifier (e.g., if ## is 03, the REN is 0.3). In most, but not all areas, the sum of all RENs should be five (5.0) or less. For more information, contact your telephone service provider.

This equipment may not be used with Party Lines. If you have specially wired alarm dialing equipment connected to your telephone line, ensure the connection of this equipment does not disable your alarm equipment. If you have questions about what will disable alarm equipment, consult your telephone service provider or a qualified installer.

If this equipment is malfunctioning, it must be unplugged from the modular jack until the problem has been corrected. Repairs to this telephone equipment can only be made by the manufacturer or its authorized agents. For repair procedures, follow the instructions outlined under the Limited warranty.

If this equipment is causing harm to the telephone network, the telephone service provider may temporarily discontinue your telephone service. The telephone service provider is required to notify you before interrupting service. If advance notice is not practical, you will be notified as soon as possible. You will be given the opportunity to correct the problem and the telephone service provider is required to inform you of your right to file a complaint with the FCC. Your telephone service provider may make changes in its facilities, equipment, operation, or procedures that could affect the proper functioning of this product. The telephone service provider is required to notify you if such changes are planned.

If this product is equipped with a corded or cordless handset, it is hearing aid compatible.

If this product has memory dialing locations, you may choose to store emergency telephone numbers (e.g., police, fire, medical) in these locations. If you do store or test emergency numbers, please:

Remain on the line and briefly explain the reason for the call before hanging up.

Perform such activities in off-peak hours, such as early morning or late evening.

Industry Canada

Operation is subject to the following two conditions: (1) this device may not cause harmful interference, and (2) this device must accept any interference received, including interference that may cause undesired operation.

The term "IC:" before the certification/registration number only signifies that the Industry Canada technical specifications were met.

Privacy of communications may not be ensured when using this telephone.

The Ringer Equivalence Number (REN) for this terminal equipment is 1.0. The REN is an indication of the maximum number of devices allowed to be connected to a telephone interface. The termination on an interface may consist of any combination of devices subject only to the requirement that the sum of the RENs of all the devices does not exceed five.

This product meets the applicable Industry Canada technical specifications.

Appendix

Limited warranty

What does this limited warranty cover?

The manufacturer of this VTech Product warrants to the holder of a valid proof of purchase (“Consumer” or “you”) that the Product and all accessories provided in the sales package (“Product”) are free from defects in material and workmanship, pursuant to the following terms and conditions, when installed and used normally and in accordance with the Product operating instructions. This limited warranty extends only to the Consumer for Products purchased and used in the United States of America and Canada.

What will VTech do if the Product is not free from defects in materials and workmanship during the limited warranty period (“Materially Defective Product”)?

During the limited warranty period, VTech’s authorized service representative will repair or replace at VTech’s option, without charge, a Materially Defective Product. If we repair the Product, we may use new or refurbished replacement parts. If we choose to replace the Product, we may replace it with a new or refurbished Product of the same or similar design. We will retain defective parts, modules, or equipment. Repair or replacement of the Product, at VTech’s option, is your exclusive remedy. VTech will return the repaired or replacement Products to you in working condition. You should expect the repair or replacement to take approximately 30 days.

How long is the limited warranty period?

The limited warranty period for the Product extends for ONE (1) YEAR from the date of purchase. If VTech repairs or replaces a Materially Defective Product under the terms of this limited warranty, this limited warranty also applies to repaired or replacement Product for a period of either (a) 90 days from the date the repaired or replacement Product is shipped to you or (b) the time remaining on the original one-year warranty; whichever is longer.

What is not covered by this limited warranty?

This limited warranty does not cover:

1. Product that has been subjected to misuse, accident, shipping or other physical damage, improper installation, abnormal operation or handling, neglect, inundation, fire, water or other liquid intrusion; or
2. Product that has been damaged due to repair, alteration or modification by anyone other than an authorized service representative of VTech; or
3. Product to the extent that the problem experienced is caused by signal conditions, network reliability, or cable or antenna systems; or
4. Product to the extent that the problem is caused by use with non-VTech accessories; or
5. Product whose warranty/quality stickers, product serial number plates or electronic serial numbers have been removed, altered or rendered illegible; or
6. Product purchased, used, serviced, or shipped for repair from outside the United States of America or Canada, or used for commercial or institutional purposes (including but not limited to Products used for rental purposes); or
7. Product returned without a valid proof of purchase (see item 2 on the next page); or
8. Charges for installation or set up, adjustment of customer controls, and installation or repair of systems outside the unit.

Appendix

Limited warranty

How do you get warranty service?

To obtain warranty service, please visit our website at www.vtechcanada.com or call 1 (800) 267-7377.

NOTE: Before calling for service, please review the user's manual - a check of the Product's controls and features may save you a service call.

Except as provided by applicable law, you assume the risk of loss or damage during transit and transportation and are responsible for delivery or handling charges incurred in the transport of the Product(s) to the service location. VTech will return repaired or replaced Product under this limited warranty. Transportation, delivery or handling charges are prepaid. VTech assumes no risk for damage or loss of the Product in transit. If the Product failure is not covered by this limited warranty, or proof of purchase does not meet the terms of this limited warranty, VTech will notify you and will request that you authorize the cost of repair prior to any further repair activity. You must pay for the cost of repair and return shipping costs for the repair of Products that are not covered by this limited warranty.

What must you return with the Product to get warranty service?

1. Return the entire original package and contents including the Product to the VTech service location along with a description of the malfunction or difficulty; and
2. Include a "valid proof of purchase" (sales receipt) identifying the Product purchased (Product model) and the date of purchase or receipt; and
3. Provide your name, complete and correct mailing address, and telephone number.

Other limitations

This warranty is the complete and exclusive agreement between you and VTech. It supersedes all other written or oral communications related to this Product. VTech provides no other warranties for this Product. The warranty exclusively describes all of VTech's responsibilities regarding the Product. There are no other express warranties. No one is authorized to make modifications to this limited warranty and you should not rely on any such modification.

State/Provincial Law Rights: This warranty gives you specific legal rights, and you may also have other rights, which vary from state to state or province to province.

Limitations: Implied warranties, including those of fitness for a particular purpose and merchantability (an unwritten warranty that the Product is fit for ordinary use) are limited to one year from the date of purchase. Some states/provinces do not allow limitations on how long an implied warranty lasts, so the above limitation may not apply to you. In no event shall VTech be liable for any indirect, special, incidental, consequential, or similar damages (including, but not limited to lost profits or revenue, inability to use the Product or other associated equipment, the cost of substitute equipment, and claims by third parties) resulting from the use of this Product. Some states/provinces do not allow the exclusion or limitation of incidental or consequential damages, so the above limitation or exclusion may not apply to you.

Please retain your original sales receipt as proof of purchase.

Appendix

Technical specifications

Frequency control	Crystal controlled PLL synthesizer
Transmit frequency	Handset: 1921.536-1928.448 MHz Telephone base: 1921.536-1928.448 MHz Doorbell: 1921.536-1928.448 MHz
Channels	5
LCD	128 (RGB) x 160 DOTS; 1.77"; TFT PANEL
Nominal effective range	Maximum power allowed by FCC and IC. Actual operating range may vary according to environmental conditions at the time of use.
Power requirements	Handset unit: 2.4V Ni-MH battery Doorbell unit: Two 2A batteries Base unit power adapter: input: 100 - 120V AC 50/60Hz output: 6V DC @ 400mA Doorbell unit power adapter: input: 100 - 240V AC 50/60Hz output: 6V DC @ 600mA Charger unit power adapter: input :117V AC 50/60Hz output: 6V AC @ 300mA
Memory	Directory: 50 memory locations; up to 30 digits and 15 characters Caller ID log: 50 memory locations; up to 24 digits and 15 characters

Index

A

- Add a directory entry, 63–64
- Add a handset, 88
- Alphabetical search, 65
- Announcement, 75
- Answer a call, 47
- Answer on/off, 77

B

- Base layout, 24–25
- Battery, 3, 4, 9, 92

C

- Call screening, 78, 83
- Call transfer, 52
- Call waiting, 48
- Caller ID log, 70
- Caller ID log messages, 74
- Chain dialing, 49
- Charging, 4
- Chime tone, 31
- Chime volume, 31
- Clock, 33

D

- Date and time, 33
- Delete a caller ID log entry, 74
- Delete a directory entry, 66
- Detach doorbell, 20
- Dial a caller ID log entry, 73
- Dial a directory entry, 66
- Dial mode, 42
- Dialing options, 72
- Directory, 62–68
- Doorbell battery installation, 9
- Doorbell layout, 28
- Doorbell operation, 44–46

E

- Edit a directory entry, 66
- End a call, 47

F

- FCC, ACTA and IC regulations, 107–109
- Find handset, 50

H

- Handset battery charging, 4
- Handset battery installation, 3

- Handset icons, 91
- Handset layout, 26–28
- Handset lights, 91
- Handset locator, 50
- Home area code, 43

I

- Important safety instructions, 103
- Installation (battery), 3, 9
- Installation (doorbell), 14–19, 21–23
- Installation (telephone base), 2
- Intercom, 54–56

J

- Join a call, 53

K

- Key tone, 42

L

- Language, 34, 35
- Layout, 24–28
- Limited warranty, 109–111
- Locating the doorbell, 10–13

M

- Maintenance, 105
- Make a call, 47
- Menu, 29
- Message playback, 84–85
- Missed call indicator, 71
- Mute, 48

N

- Night vision, 46
- Number of rings, 78

O

- Operating range, 104
- Operation, 44–46, 47–52, 81–87
- Options during message playback, 84, 85

P

- Parts checklist, 1
- Precautions for users of implanted cardiac pacemakers, 104
- Predial, 47

Q

- Quiet mode, 32

Index

R

- Redial, 51
- Remote access, 87
- Remote access code, 79
- Review the caller ID log, 71
- Ringer tone, 30
- Ringer volume, 30

S

- Safety instructions, 103
- Save a caller ID log entry, 73
- Screen messages, 74, 89–90
- Settings, 30–43, 75–80
- Share a call, 53
- Speakerphone, 47

T

- Technical specifications, 111
- Telephone base layout, 24–26
- Telephone base lights, 91
- Temporary ringer silencing, 48
- Temporary tone dialing, 49
- Transfer a call, 52
- Troubleshooting, 93–102

U

- Using the menu, 29

V

- Video streaming, 44–45
- Voice language, 35
- Voicemail, 40, 41, 50, 81
- Voicemail indicators, 41
- Volume, 30, 31, 48

W

- Warranty, 109–110



Designed to fit your home.
And your life.

VTech Technologies Canada Ltd.
A member of THE VTECH GROUP OF COMPANIES.
VTech is a registered trademark of VTech Holdings Limited.
Specifications are subject to change without notice.
© 2014 VTech Technologies Canada Ltd.
All rights reserved. 12/14. IS7121-X_CA_WEBCIB_V5.0

